

I Foreword	15
Introduction	16
The Owner's Handbook	16
Status at Time of Printing	16
Symbols Used	17
Identification Information	18
Vehicle Identification	18
Vehicle Identification Label	19
Instructions for Use of Electric Vehicle	21
Effects of Ambient Temperature	21
Instructions for High Voltage Battery Pack Recycling	21
Driving Range.....	22
Equalisation Charging.....	23
Intelligent Charging.....	23
Crash Outage Control	24
High Voltage System.....	24
Precautions in the Event of an Accident	26
2 Instruments and Controls	29

CONTENTS

Instrument Pack	30
Instrument Information Display Operation	30
Message Centre.....	32
Warning Message.....	33
Warning Lamps and Indicators.....	35
Lights and Switches.....	49
Master Light Switch.....	49
Headlamp Leveling Adjustment	51
Light Lever Switch	52
Direction Indicators	55
Rear Fog Lamps.....	56
Hazard Warning Lamps	56
Wipers and Washers.....	57
Front Windscreen Wiper and Washer Operation	57
Front Windscreen Wash and Wipe	58
Steering System	59
Steering Wheel Position Adjustment.....	59
Electric Power Steering.....	59
Steering Mode Switching.....	60

Horn	61
Power Socket	62
Front Console Power Socket.....	62
Rear USB Port.....	63
Wireless Charging System for Mobile Phones *	64
Wireless Charging of Mobile Phones.....	64
Rearview Mirrors	66
Exterior Rearview Mirrors	66
Interior Rearview Mirror	68
Sunvisor	70
Windows	71
Power Operated Window Switch	71
Window Operation.....	72
Interior Light	74
Manual Operation.....	74
Automatic Operation	74
Driver Monitor System	75
Indirect Driver Fatigue Reminder System *	75

CONTENTS

Direct Driver Monitor System *	76
Storage Devices	78
Instructions for Use	78
Glove Box	78
Storage Box	79
Glasses Box	80
Cup Holder	82
Centre Console Cup Holder	82
3 Air Conditioning and Audio Systems	83
Ventilation	84
A/C Filter	85
Vents	85
A/C Control Panel	87
Control Panel	87
A/C Control Shortcut	87
Defrost/Demist Button	87
Heated Rear Window Button	88
Air Conditioning Control Interface	89

CONTENTS

Air Conditioning Control Interface - Connected Car *	89
System On/Off	90
Cooling On/Off	90
Auto Mode	90
Air Recirculation Mode	90
Economy Mode	91
Air Distribution Mode	91
Blower Speed Control	92
Temperature Control	92
Infotainment System *	93
Important Safety Information	93
Privacy and Data Sharing	94
Precautions for Screen Usage	94
Basic Operations	95
Bluetooth Phone	99
Entertainment	101
Vehicle-Mobile Phone Interconnection	107
MG Touchpoint	108
Vehicle Settings	108
Settings	108

CONTENTS

4 Seats and Restraints	111
Seat	112
Seat Positions and Backrest Angle	112
Head Restraints	113
Front Seats	114
Rear Seats	116
Front Seat Heating Function *	117
Seat Belts	118
Protection Provided by Seat Belts	119
Wearing Seat Belts	120
Children and Seat Belts	123
Seat Belt Pre-tensioners	125
Seat Belt Checks, Maintenance and Replacement	126
Airbag Supplementary Restraint System	129
Overview	129
Airbag Deployment	131
Conditions in Which Airbags Will Not Deploy	135
Service and Replacement of Airbags	138
Disposal of Airbags	139

Child Restraints	140
Important Safety Instructions about Using Child Restraints	140
Fixing Child Restraints	144
Approved Child Restraint Positions	147
5 Starting & Driving	153
Keys	154
Overview	154
Replacing the Smart Key Battery	155
Child Proof Locks	158
Starting and Stopping the Power System	159
Starting the Power System	159
Switching the Power System OFF	160
Economical and Environmental Driving	161
Running-in	161
Economic Driving	161
Driving in Special Environment	162
Check and Service	163
Charging and Discharging Requirements	164

CONTENTS

Charging Your Vehicle at Home	166
Installed Charging Points	166
Home Charging Guide.....	166
Charging and Medical Condition Awareness	167
Charging Port	167
Electric Charging Identifier Label *	169
Rapid Charging	172
Slow Charging.....	173
Charging Information	175
Equalisation Charging.....	176
Charging Times	176
Discharging.....	180
Pedestrian Alert System.....	182
Electric Drive Transmission.....	183
Instructions for Use	183
Gear Shift Control.....	183
Driving Mode	185
Energy Regeneration.....	186
Energy Saving Mode.....	187

Protection Mode.....	187
Brake System.....	189
Overview	189
Parking Brake System - Electronic Parking Brake (EPB)	190
Service Brake System.....	192
Adaptive Cruise Control System.....	199
Activation of Adaptive Cruise Control.....	199
Adaptive Cruise Target Following Distance Adjustment.....	201
Adaptive Cruise Target Speed Adjustment.....	201
Adaptive Cruise Pause/Standby	202
Automatic Deactivation of Adaptive Cruise	202
Adaptive Cruise Override	203
Adaptive Cruise Resume.....	203
Clearing Target Speed Memory.....	203
Special Driving Environments.....	204
Driving Assist System	207
Description of Front View Camera.....	207
Description of Front Detection Radar	208
Speed Sign Recognition	210

CONTENTS

Speed Limit Assistance System.....	212
Lane Assist System	217
Traffic Jam Assist System.....	220
Forward Collision System.....	223
Parking Aid.....	227
Ultrasonic Sensor Parking Aid.....	227
360 Around View System *	229
Rear Driving Assistance System *	230
System Overview.....	230
Switching the System Functions On/Off.....	231
Blind Zone Safety Assist.....	231
Rear Cross Traffic Assist.....	233
Rear Collision Warning.....	235
Door Opening Warning.....	236
Tyre Pressure Monitoring System (TPMS).....	238
Load Carrying.....	240
Loadspace Loading.....	240
Internal Loading.....	241
General Towing Safety.....	241

Alarm System	243
Power Immobiliser	243
Anti-theft System	244
Manual Tailgate	247
Emergency Tailgate Opening	248
6 Emergency Information	251
Hazard Warning Devices	252
Warning Triangle	252
Vehicle Recovery	253
Towing for Recovery	253
Transporter or Trailer	256
eCall - SOS Emergency Assistance	257
Emergency Starting	259
Tyre Repair	262
Tool Identification (including tyre repair tool)	263
Tyre Repair	263
Changing a Wheel *	266
Fuse Replacement	269

CONTENTS

Fuse.....	269
Passenger Compartment Fuse Box	270
Front Compartment Fuse Box	273
Bulb Replacement	277
Bulb Specification.....	277
Replacement	277
7 Service and Maintenance	285
Maintenance.....	286
Routine Servicing.....	286
Bonnet	289
Opening the Bonnet.....	289
Closing the Bonnet.....	289
Bonnet Open Alarm.....	289
Front Compartment	290
Battery.....	291
Battery Maintenance	291
Battery Replacement.....	292
Cooling System.....	293

Coolant Check and Top Up	293
Coolant Specification	293
High Voltage Battery Pack	295
Precautions and restricted conditions for use of battery	295
Washer	298
Washer Fluid Check and Top Up	298
Washer Nozzles	299
Wipers	300
Wiper Blades	300
Replacing Front windscreen Wiper Blades	301
Brake	302
Brake Fluid Check and Top Up	302
Brake Fluid Specification	303
Tyre	304
Overview	304
Caring for Your Tyres	306
Tyre Wear Indicators	307
Tyre Rotation	308
Tyre/Snow Chains	308

CONTENTS

Cleaning and Vehicle Care	310
Exterior	310
Cleaning the Interior.....	313
8 Technical Data	315
Technical Data Dimensions	316
Weights	318
Towing Weights	319
Electric Drive Transmission	320
Recommended Fluids and Capacities	321
Four-Wheel Alignment Parameter Table (Unladen)	322
Wheels and Tyres	323
Tyre Pressure (Cold)	324

Foreword

- 16 Introduction*
- 18 Identification Information*
- 21 Instructions for Use of Electric Vehicle*

FOREWORD

Introduction

The Owner's Handbook

This handbook describes all of the vehicles and standard equipment specification within the model range. Some of the information, therefore, may not apply to your particular car.

Always remember that if you have any queries concerning the operation or specification of your car, your MG Authorised Repairer will be glad to advise you.

The illustrations in the Owner's Handbook are for reference only.

The information presented in this manual may vary slightly depending on vehicle configuration, software version and sales area.

Status at Time of Printing

MG operates a policy of constant product improvement and therefore reserves the right to change specifications without notice at any time.

Whilst every effort is made to ensure complete accuracy of the information in this publication, no liabilities for inaccuracies or the consequences thereof, including loss or damage to property, or injury to persons, can be accepted by the manufacturer or the MG Authorised Repairer who supplied the publication, except in respect of personal injury caused by the negligence of the manufacturer or the MG Authorised Repairer .

Symbols Used

Warning



This warning symbol identifies procedures that must be followed precisely, or information that must be considered with great care, in order to reduce the risk of personal injury or serious damage to the car.

Important

IMPORTANT
The statements stated here must be followed strictly, otherwise your car could be damaged.

Note

Note: *This describes helpful information.*



This symbol indicates that parts described must be disposed of by authorised persons or bodies to protect the environment.

Asterisk

An asterisk (*) appearing within the text identifies features or items of equipment that are either optional, or that only some vehicles in the model range are equipped with.

Illustration Information



Identifies components being explained.



Identifies movement of components being explained.

FOREWORD

Identification Information

Vehicle Identification

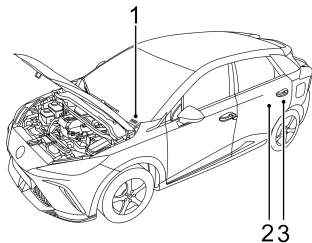

- 1 Vehicle Identification Number (VIN)
- 2 Drive Motor Number
- 3 Electric Drive Transmission Number

Always quote the Vehicle Identification Number(VIN) when communicating with an MG Authorised Repairer. If

the drive motor or electric drive transmission is involved, it may be required to provide the identification numbers of these assemblies.

Vehicle Identification Location

Vehicle Identification Number

- On the floor under the driver's seat;
- Stamped on a plate visible through the bottom left hand corner of the windscreen;
- On the identification plate;
- On the inner side of the tailgate; visible by opening the tailgate.

Note:

The DLC is located in the driver footwell at the base of the fascia panel on the LH side. The VIN information can be extracted from the vehicle using the approved diagnostic equipment.

Drive Motor Number

Stamped on the lower part of the drive motor housing.

Electric Drive Transmission Number

Stamped on the upper part of the electric drive transmission housing.

Vehicle Identification Label

The Vehicle Identification Label contains the following information:

- Type Approval Number
- Vehicle Identification Number (VIN)
- Gross Vehicle Weight
- Gross Train Weight
- Max Front Axle Weight
- Max Rear Axle Weight
- Paint Code
- Trim Code

FOREWORD

Location of Vehicle Identification Label

The Vehicle Identification Label is located at the lower side of right side B pillar.

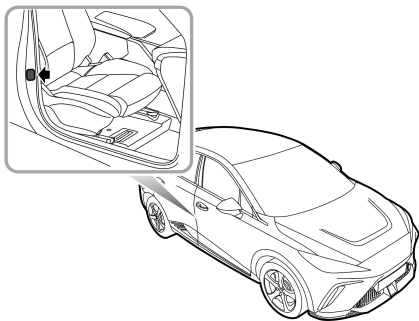

Instructions for Use of Electric Vehicle

Effects of Ambient Temperature

The working performance of the high voltage battery pack fitted to your vehicle is related to the ambient temperature. This battery powers the vehicle power system and therefore it is recommended that where possible the vehicle should be used within the temperature range of -15°C~45°C. This will ensure that the vehicle is in the optimum working state, and help extend the service life of the high voltage battery pack. Extremely high or low temperatures will affect the performance of the high voltage battery pack and vehicle.

Instructions for High Voltage Battery Pack Recycling

The high voltage battery pack fitted to your vehicle contains several lithium based battery cells. It is installed centrally to the motor-vehicle chassis. Arbitrary disposal may cause pollution, hazard and damage to the environment. The high voltage battery pack **MUST** be recycled by an MG Authorised Repairer or a professional

approved dismantling agent. Please refer to the following information and requirements.

- **ONLY** qualified personnel should work with the high voltage system - there is danger of **DEATH**.
- **High voltage safety:** the high voltage system fitted to your vehicle features a HV battery containing high voltage components such as lithium battery packs and high voltage wiring harness; **DO NOT** attempt to dismantle any area of this system, suitably trained professional staff must observe insulation safety protection before working on or near the high voltage system.
- **Transportation:** The high voltage battery pack is classed as a **Category 9** hazardous material and must be transported by vehicles qualified in transporting **Category 9** hazardous materials.
- **Storage:** All HV components (including batteries) should be stored at room temperature and in a dry environment. They must be kept away from dangerous sources, such as flammable objects, heat and water sources.

FOREWORD

- Internal composition: The high voltage battery pack consists of lithium batteries (pack), PCB, HV and normal electric wiring, metal casing and other components.

It is strongly recommended that the used high voltage battery pack generated from vehicle scrappage or any other reasons should be disposed of by an MG Authorised Repairer.

Note: If you decide not to use the recommended MG Authorised Repairer to dispose of your high voltage battery, the responsibility of the consequences of environmental pollution or accidents must be borne by the owner.

Driving Range

The driving range of your vehicle depends on the HV battery condition, quantity of available electricity, vehicle age (current remaining battery life), weather, temperature, road conditions and driving habit etc.

The range can be affected by other electrical loads (such as A/C, lights etc), driving style and general road conditions.

It should be noted that:

- The driving range is related to the rate of discharge. In order to avoid a high rate of discharge from affecting the performance of the high voltage battery pack, it is recommended that the vehicle is connected to a suitable charger upon illumination of the low battery warning lamp in the instrument pack.
 - The actual driving range of the vehicle will reduce with the increase of vehicle age.
 - The use of A/C will reduce the driving range.
 - The driving range varies at different speeds.
 - At low temperatures, the driving range will be reduced due to temperature characteristics of the battery during use.
 - In some instances of extreme temperatures and low battery voltage, you may experience insufficient acceleration or power reduction. This is due to battery characteristics.
- To help increase the range of the vehicle please observe the following:
- Have the vehicle regularly maintained as per service schedule.
 - Always ensure the tyre pressures are correct.

- Try and use the vehicle between the recommended ambient temperatures.
- Do not park or store the vehicle for long periods with a low state of charge, where possible charge the vehicle as soon as possible prior to storage.
- Remove unnecessary articles to reduce the vehicle load.
- Use of high power consuming systems such as A/C and heating will use large amounts of power. This will reduce the driving range.
- At a high speed, where possible, close the windows to reduce wind resistance and power consumption.
- Try to maintain a steady speed at all times, avoid constant acceleration and braking.
- During acceleration, apply the accelerator pedal as gently as possible.
- During deceleration, release the accelerator pedal; under certain conditions when not applying the brake or gently applying the brake, the energy regeneration system (KERS) will assist in charging the HV battery and extend the driving range.

Equalisation Charging

In order to assist in extending the service life of the high voltage battery pack it is recommended that an equalisation charge is carried out at regular intervals.

Please see "Equalisation Charging" in the "Starting & Driving" section.

Intelligent Charging

The 12V battery SOC (State Of Charge) is constantly monitored, when the vehicle is power OFF it is possible, under certain conditions, that the HV battery will automatically charge the 12V battery to ensure the vehicle starts. This function will activate and switch off automatically.

Note: The system will suspend intelligent charging if a fault is present, when starting or the vehicle is being charged by an external device.

Note: The driving range will be reduced after intelligent charging.

Note: The intelligent charging function is suspended when the high voltage battery is in a low SOC.

FOREWORD

Crash Outage Control

If a crash or serious impact occurs, a signal from the SDM (Airbag Control Module) will disconnect the relays within the battery management system isolating the high voltage battery from the systems on the vehicle.

High Voltage System



- *The high voltage system used on your vehicle features AC and DC voltages up to about 452.4V. All high voltage components have warning labels attached - please observe these warnings and any requirements when operating within or close to these areas.*
- *ONLY qualified personnel should work on, or with, the high voltage system - there is danger of DEATH.*

The high voltage system component layout is shown below:

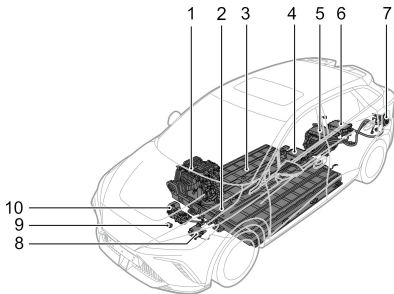

- 1 Electric Heater
- 2 High Voltage Harness
- 3 High Voltage Battery (ESS)
- 4 Power Distribution Unit (PDU)
- 5 Electric Drive Transmission
- 6 Combined Charging Unit (CCU)
- 7 Charging Port
- 8 HV Battery Heater
- 9 Manual Service Disconnect (MSD)
- 10 Electric A/C Compressor

FOREWORD

Precautions in the Event of an Accident



- *Ensure the vehicle is in P, the parking brake is applied and the vehicle power system is OFF.*
- *If any cables on the vehicle are exposed, in order to prevent electric shock or even death DO NOT make any contact with any cable.*
- *If the vehicle catches fire, and the fire is small and slow, a carbon dioxide extinguisher can be used to extinguish the fire, and contact the fire services as soon as possible; if the fire is large and spreading quickly, immediately evacuate the vehicle and contact the fire services immediately.*
- *If the vehicle is involved in a collision and cannot be re-started, the negative cable of 12V battery and Manual Service Disconnect (MSD) MUST be disconnected prior to rescue.*
- *When the vehicle is completely or partially immersed in water, switch off the vehicle power system and evacuate the car immediately. The negative cable of 12V battery and Manual Service Disconnect (MSD) MUST be disconnected prior to rescue or as soon as the vehicle is refloated/removed from the water. Observe the water/vehicle for any abnormal signs such as excessive bubbles or noises, this may indicate battery short circuit issues. If no signs are evident, there should not be a shock risk from the body work and recovery can commence.*
- *If your car is being recovered by an independent recovery agent, please contact an MG Authorised Repairer for guidance.*
- *The vehicle is supplied with an emergency response information card.*

*Please show the card to the rescue
personnel when they arrive.*



Instruments and Controls

- | | | | |
|----|--|----|------------------------------|
| 30 | <i>Instrument Pack</i> | 75 | <i>Driver Monitor System</i> |
| 35 | <i>Warning Lamps and Indicators</i> | 78 | <i>Storage Devices</i> |
| 49 | <i>Lights and Switches</i> | 82 | <i>Cup Holder</i> |
| 57 | <i>Wipers and Washers</i> | | |
| 59 | <i>Steering System</i> | | |
| 61 | <i>Horn</i> | | |
| 62 | <i>Power Socket</i> | | |
| 64 | <i>Wireless Charging System for Mobile Phones*</i> | | |
| 66 | <i>Rearview Mirrors</i> | | |
| 70 | <i>Sunvisor</i> | | |
| 71 | <i>Windows</i> | | |
| 74 | <i>Interior Light</i> | | |

INSTRUMENTS AND CONTROLS

Instrument Pack

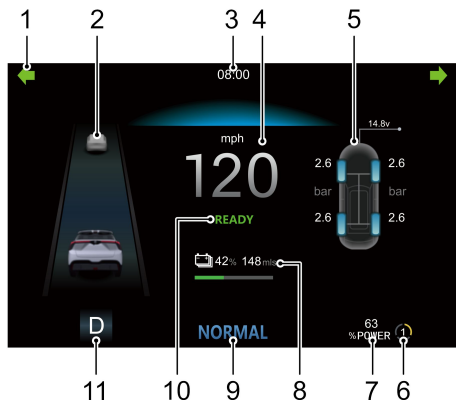

- 1 Warning Lamps and Indicators
- 2 Active Safety
- 3 Time
- 4 Speedometer
- 5 Message Centre
- 6 Energy Regeneration Mode
- 7 Power Meter
- 8 Electricity Meter and Range to Empty
- 9 Driving Mode
- 10 Power System Status
- 11 Gear Display

Instrument Information Display Operation

The message centre function can be selected with the buttons on the right of the multifunction steering wheel as follows:

INSTRUMENTS AND CONTROLS

The function adjustment button (1 as shown) is a dual-purpose button. Pressing this button will switch control between the Infotainment or Instrument pack.

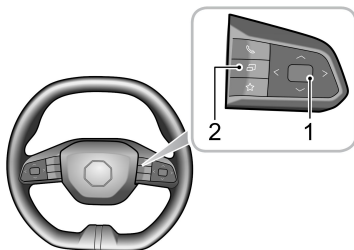

1 Function Adjustment Button (OK Button)

- Push the button up, down, left or right to switch the message centre display items.
- Push the button up or down to make adjustments.
- Short press the button to confirm, or long press it to reset.

2 Infotainment /Instrument Button

INSTRUMENTS AND CONTROLS

Message Centre

The message centre provides the followings:

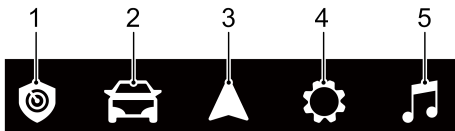

- 1 Health Centre
- 2 Trip Computer
- 3 Navigation *
- 4 Settings
- 5 Multimedia *

Health Centre

- Tyre Pressure: Displays the current status of each wheel.
- Battery Voltage: Displays the 12V Battery Voltage.

- Warning Information: Displays the warning information or important notes that are currently relevant to the vehicle.

Trip Computer

The trip computer function contains the following:

- From Start: Displays the range, duration, average speed and average energy consumption since startup. When the vehicle is powered off for a period of time, these values will be reset. They can also be reset by long pressing the OK button.
- Accumulated Total: Displays the range, duration, average speed and average energy consumption since the last reset. They can be reset by long pressing the OK button.
- From Last Charge: Displays the range, duration, average speed and average energy consumption since the last charge. They can be reset by long pressing the OK button.
- Odometer Displays the total distance the car has travelled.

Navigation *

Displays the navigation message from the infotainment mainframe.

Settings

- **Luminance Level:** Displays and adjusts the backlight brightness.
- **OverSpeed Threshold:** Sets the speed limit of overspeed alarm.
- **Next Service:** Reminds the driver of the mileage until the next vehicle maintenance.

Multimedia *

Displays the multimedia message from the infotainment mainframe.

Warning Message

The message centre of instrument pack displays the warning messages in pop-up windows. The warning messages are mainly divided into the following:

- Operation Instructions
- System State Reminder

- System Failure Alert

Please follow the text prompts or refer to the sections related to the control system for the failure causes and appropriate solutions.

When the following warning information appears, please stop the vehicle as soon as safety permits, shut down the engine and contact an MG Authorised Repairer for service immediately

- DANGER! Evacuate Vehicle Safely
- Escape from the vehicle immediately
- Vehicle Control System Fault, Please Stop Safely
- Occupancy Sensor Fault
- EPS Assistance Failure
- Brake Fluid Level Low
- Brake System Fault

When the following warning information appears, please contact an MG Authorised Repairer for service as soon as possible:

- Airbag Fault
- ESCL Fault





INSTRUMENTS AND CONTROLS

- Vehicle Control System Fault, Take Vehicle to MG Dealer
- Vehicle Control System Fault, Please drive carefully!
- Cruise Control System Failure
- Speed Limit Recognition System Failure
- Speed limit system failure
- System Fault Unable to Restart
- Parking System Fault
- Gearbox Fault
- Motor Fault Reverse Gear Not Available
- Power Mode Fault
- Passive Entry Fault
- Tyre Pressure System Failed
- Front Left/Front Right/Rear Left/Rear Right Tyre Sensor Battery Low
- 12V Battery Charging System Fault
- EPS Performance Reduced
- Steering Angle Sensor not Calibrated
- Steering Angle Fault
- ABS Fault
- Stability Control Fault
- Traction Control Fault
- Autohold Fault
- Park Brake Force Too Low
- RADAR Calibration Failed
- Front Camera Calibration Failed
- Front Camera System Fault
- Intelligent Driving Assist Sensor Failure
- ACC System Fault
- Lane Departure Warning System Fault
- Lane Keep Assist System Fault
- Forward Collision System Fault
- Auto Emergency Braking System Fault
- Traffic Jam Assist System Fault
- Rear Drive Assist System Fault
- Driver Monitor System Fault
- Driver Drowsiness Detection System Fault
- eCall System Fault
- eCall System Failure





Warning Lamps and Indicators

If any warning light or indicator appears in the instrument during the process of vehicle starting or driving, it means that the relevant system is in a certain state or has a fault. Some warning lights will illuminate or flash accompanied with warning tone or prompt message.

Please read the following instructions in detail for the meaning of the relevant warning lights and indicators. In case of failure, please take corresponding measures in time and contact an MG Authorised Repairer as soon as possible.



Name	Icon	Note
Dipped Beam Indicator		This indicator illuminates when the headlamp dipped beam is turned on.
Main Beam Indicator		This indicator illuminates when the headlamp high beam is turned on.
Auto Main Beam Indicator		The indicator illuminates when the auto main beam function is enabled.
Side Lamp Indicator		This indicator illuminates when the side lamps are on.

INSTRUMENTS AND CONTROLS



Rear Fog Lamp Indicator		This indicator illuminates when the rear fog lamps are on.
Direction Indicators		<p>The left and right direction indicator lamps are represented by directional arrows that are located at the top of the instrument pack. When the turning signal lamp flashes, the direction indicator lamp on the corresponding side also flashes. If the hazard warning lamps are operated, both direction indicator lamps will flash together.</p> <p>If either direction indicator lamp in the instrument pack flashes very rapidly, it indicates that the turning signal light on the corresponding side has failed.</p>
Airbag Warning Lamp		If this lamp illuminates, it indicates that the SRS or the seat belt has failed. As soon as conditions permit, safely stop the vehicle and switch the vehicle power system to the OFF position and contact an MG Authorised Repairer immediately. An SRS or seat belt fault may mean the components may not be deployed in the event of an accident.
Seat Belt Unfastened Warning Lamp		If this lamp illuminates or flashes, it indicates that the seat belt for the driver or passenger remains unfastened.

INSTRUMENTS AND CONTROLS

2







<p>Anti-theft Alarm Indicator</p>		<p>If no valid key is detected, this lamp will illuminate red. Please use the correct key, or put the smart key at the alternative starting position. For specific location requirements, refer to "Alternative Starting Procedure" in "Starting & Driving" section. If the remote key battery is low, this lamp flashes. Please replace the battery as soon as possible.</p>
<p>Tyre Pressure Monitoring System (TPMS) Warning Lamp</p>		<p>If this warning lamp illuminates, it indicates that a tyre pressure is low. Please check the tyre pressures.</p> <p>If this lamp flashes first and then remains illuminated after a period of time, it indicates the system has detected a fault. Please contact an MG Authorised Repairer as soon as possible.</p>

INSTRUMENTS AND CONTROLS





Electric Power Steering (EPS) Warning Lamp		If this lamp illuminates yellow, it indicates the electric power assisted steering system has a general failure and the performance is reduced. Please stop the car as soon as safety permits. If the lamp still illuminates after restarting the vehicle and driving for a short while, please contact an MG Authorised Repairer immediately.
		<p>If this lamp illuminates red, it indicates the electric power assisted steering system has a general failure relevant to steering angle sensing. Please contact an MG Authorised Repairer as soon as possible.</p> <p>If this lamp illuminates red and flashes, it indicates the electric power assisted steering system has a severe failure. Please contact an MG Authorised Repairer immediately.</p>
Dynamic Stability Control/Traction Control System Warning Lamp		<p>If this lamp illuminates, it indicates that the dynamic stability control system or traction control system has detected a fault.</p> <p>This lamp will also flash when driving to indicate that the system is operating and assisting the driver.</p>

INSTRUMENTS AND CONTROLS

2







<p>Dynamic Stability Control/Traction Control System OFF Warning Lamp</p>		<p>The dynamic stability control/traction control system has been turned off.</p>
<p>Auto Hold System Indicator</p>		<p>The auto hold system is operating to assist the driver.</p>
		<p>The auto hold system has detected a fault.</p>
		<p>The auto hold system function is activated and in standby state.</p>
<p>Electronic Parking Brake (EPB) System Status Indicator</p>		<p>If this lamp illuminates, it indicates that the EPB is enabled. If this lamp flashes, it indicates that the vehicle is parked on an excessive slope or the EPB system has failed. Please park on a safe road.</p>
<p>Electronic Parking Brake (EPB) System Malfunction Warning Lamp</p>		<p>The electronic parking brake system is failed.</p>

INSTRUMENTS AND CONTROLS



Brake System Malfunction Warning Lamp		The brake system has failed. Please stop the vehicle as soon as safety permits, and power down the vehicle.
ABS Malfunction Warning Lamp		<p>The ABS has detected a fault. Please contact an MG Authorised Repairer immediately.</p> <p>If an ABS failure occurs while driving, the ABS function will be disabled while normal braking will still be available. Please contact an MG Authorised immediately.</p>
Low-voltage Battery Charging System Malfunction Warning Lamp		<p>If this lamp illuminates after starting the vehicle, it indicates that the low-voltage battery charging system has failed. Please contact an MG Authorised Repairer at the earliest opportunity.</p> <p>If this lamp flashes, it indicates that the low-voltage battery power is low. At this time, the system will restrict or turn off some electrical devices. Please start the vehicle immediately to charge the low-voltage battery.</p>
System Fault Message Indicator		The vehicle has a warning message. Please view the fault message or important notes in the message centre. Refer to "Instrument Pack" in this section.

INSTRUMENTS AND CONTROLS

2





Adaptive Cruise Control System Indicator *		The adaptive cruise control system is turned on, but not in standby state.
		The adaptive cruise control system is in standby state.
		The adaptive cruise control system is activated.
Speed Limit Assistance System Indicator *		The manual speed limit assistance system is in standby state.
		If this lamp illuminates, it indicates that the manual speed limit assistance system is activated. If this lamp flashes, it indicates that the current speed exceeds the speed limit value.
		The intelligent speed limit assistance system is in standby state.
		The intelligent speed limit assistance system is activated.

INSTRUMENTS AND CONTROLS





<p>Adaptive Cruise Control/Speed Limit Assistance System Malfunction Warning Lamp</p>		<p>The adaptive cruise control system or speed limit assistance system has detected a fault.</p>
<p>Speed Limit Marking Speed Indicator *</p>		<p>"NNN" is the speed limit marking speed currently identified. When the vehicle speed exceeds the speed limit value, the lamp flashes.</p>
<p>Speed Limit Marking Ancillary Information Warning Lamp</p>		<p>The speed limit sign currently recognised has additional information. Please pay attention to it.</p>

INSTRUMENTS AND CONTROLS

2





Traffic Jam Assist System Indicator *		The traffic jam assist system is turned on, but not in standby state.
		The traffic jam assist system is in standby state.
		The traffic jam assist system is activated.
		The traffic jam assist system has detected a fault. Please contact an MG Authorised Repairer as soon as possible.

INSTRUMENTS AND CONTROLS







Lane Keeping Assist System Indicator *		The lane keeping function is off.
		The lane keeping function is in standby state.
		The lane keeping function is activated.
		The lane keeping assist system has detected a fault.
Forward Collision Assistance System Indicator *		<p>This lamp will illuminate yellow when one of the forward collision system functions is disabled.</p> <p>When all of the forward collision system functions are enabled, if the indicator remains on, it indicates the system is not able to function normally. Please contact an MG Authorised Repairer as soon as possible.</p>

INSTRUMENTS AND CONTROLS





2

Rear Driving Assistance System Indicator *		<p>If the rear drive assist system is turned off, this lamp illuminates with prompt messages.</p> <p>If any of the rear driver assist sensors are obscured or if the system detects a fault, this lamp will illuminate, accompanied by prompt messages.</p>
Power Battery Cut-off Indicator		<p>When the high-voltage battery pack is connected, this lamp will not illuminate. This lamp will only illuminate when the high voltage battery is disconnected or isolated.</p>
High Voltage Battery Pack Malfunction Indicator		<p>This lamp will illuminate if a fault is detected or the high voltage battery has failed. Please contact an MG Authorised Repairer immediately.</p>
		<p>This lamp will flash if the high voltage battery temperature is too high. Please stop the car as soon as safety permits, power off the vehicle, and leave the vehicle immediately. Contact an MG Authorised Repairer at the earliest opportunity.</p>



INSTRUMENTS AND CONTROLS

Power System Malfunction Indicator		If this lamp illuminates yellow, it indicates that the vehicle has detected a fault and power is limited. Please contact an MG Authorised Repairer as soon as possible.
		If this lamp illuminates red, it indicates that the vehicle has detected a severe fault.
Driving Power Limited Indicator		This lamp will illuminate if the vehicle power has been limited.
Charging Connection Indicator		The charging/discharging connector has been connected.
Charging Status Indicator		A charging or discharging fault has been detected.
		The vehicle is in charging state.
		The vehicle is in discharging state.

INSTRUMENTS AND CONTROLS

Motor Malfunction Warning Lamp		If a fault or failure is detected in the motor or the power electronic box of the electric drive system, this lamp will illuminate. Please stop the vehicle as soon as safety permits, power off the vehicle and contact an MG Authorised Repairer immediately.
		When this lamp illuminates, the electric drive transmission motor or power electric box has detected a fault. Please contact an MG Authorised Repairer as soon as possible.
High Voltage Battery Pack Low Battery Warning Lamp		The high voltage battery pack is low, please charge it as soon as possible.
READY Indicator		The vehicle is ready for driving.
Driver Status Indicator		When the driver monitoring system is failed or temporarily unavailable, the status indicator will remain ON in yellow. When the driver fatigue or distraction is detected, the status indicator will flash in yellow.

INSTRUMENTS AND CONTROLS

eCall SOS Indicator		The system is ready and an emergency service call (eCall) is in progress.
		The eCall system can send out a vehicle message to the call centre, but other eCall capabilities are limited due to a fault in the system.
		If the eCall system has failed and not operational, the indicator illuminates red.

Note: *There are some circumstances where a warning light may illuminate or a warning message is displayed as an indication of an issue with the associated system, this does not necessarily indicate a fault. If in doubt, please seek advice from an MG Authorised Repairer.*

Lights and Switches

Master Light Switch

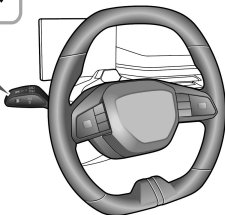

	Auto Lighting
	Side Lamps and Switch Illumination

	Headlamps
	AUTO Lighting OFF

AUTO Lightings

When the vehicle is powered on, the AUTO lighting system is turned on by default, which will automatically switch the side lamps/switch illumination on and off according to the intensity of current ambient light.

Note: *This function is controlled by a sensor mounted in your vehicle to monitor the exterior light levels in real time. It is fitted on the instrument panel near the windscreen. DO NOT mask or cover this area. Failure to adhere to this may result in headlamps on when not necessary.*

Side Lamps and Switch Illumination

When the vehicle is powered on, turn the master lighting switch to position 2 to operate the sidelamps and switch illumination.

INSTRUMENTS AND CONTROLS

When the vehicle is powered off if the lighting switch is in position 2 and the driver's door is opened an audible warning will sound to alert the driver.

Headlamps

When the vehicle is powered on, move the Headlamp Cycle switch to the position  , to turn on the dipped beams, side lamps/switch illumination.

Lamps Off

Move the Lamps Off switch to turn off the lamps. Move it again, the lamps level will automatically return to the AUTO position.

Daytime Running Lamps

The day time running lamps illuminate automatically when the vehicle power on. When the dipped headlamps are switched on, the day time running lamps extinguish automatically.

Welcome Light

When the car is unlocked, the system will automatically illuminate the dipped beams and side lamps according to the intensity of the current ambient light.

Follow Me Home

After the vehicle is powered off on the Infotainment display, pull the light lever switch towards the steering wheel. This will enable the Follow Me Home function, and dipped beam headlamps and side lamps will illuminate. Follow Me Home can be set opening and closing in the "Vehicle Settings" interface on the infotainment display.

Headlamp Leveling Adjustment

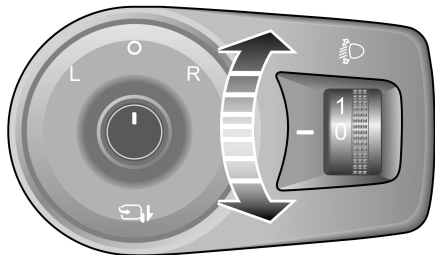

The headlamp leveling can be adjusted as per the following table according to the vehicle load.

Location	Load
0	Only driver in the car, or there is a front passenger in addition to the driver in the car.
1	All the seats occupied with no load in the Load space.
2	All the seats occupied plus an evenly distributed load in the Load space.
3	Driver only, plus an evenly distributed load in the Load space.

INSTRUMENTS AND CONTROLS

Light Lever Switch



Take care not to dazzle oncoming vehicles when switching between the main and dipped beams.

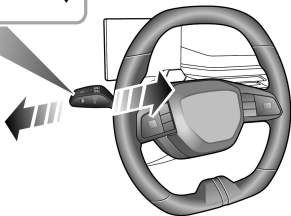

time, the main beam indicator in the instrument pack will illuminate. Push or pull the light lever switch once again to switch to the dipped beam.

Main Beam Flash

To briefly flash the main beam on and off, pull the lever towards the steering wheel and then release.

Automatic High Beam



The Automatic High Beam serves only as an auxiliary function. The driver must check the status of the front lamps, and turn on the front lamps when necessary.

Headlamp Main/Dipped Beams Switching

When the vehicle is powered on and the dipped beams are turned on, push the light lever switch towards the instrument panel to turn on the main beam. At this

IMPORTANT

The Automatic High Beam may not operate normally in the following cases, but not limited to them, so the main and dipped beams should be switched manually:

- The windscreen is dirty, broken or obstructed by other objects blocking the view of the sensor.
- The lamps of other vehicles are missing, damaged, blocked or cannot be detected due to weather and other reasons.
- When pedestrians, non-motor vehicles and other objects with no obvious light or reflected light are encountered.
- When the headlamps and tail lamps of other vehicles cannot be detected due to the sensor view being impaired due to undulating road conditions such as bends, dips or hills.
- When the car is driving on a winding road or mountainous road.
- The wiper switch is in the "Fast" position.

The automatic high beam system is designed to detect the light intensity information of the vehicle in front using the

vehicle forward camera and switch the main beam on or off when certain conditions are met. When the automatic high beam is enabled, the automatic high beam indicator in the instrument pack illuminates. For some models, the automatic high beam function can be switched on/off via the infotainment system. The automatic high beam system can be turned on or off on the large screen.

In the case of automatic control, the system will automatically turn on the main beam when the surrounding environment is dark and there is no light detected from any vehicles ahead, or oncoming vehicles; when the surrounding environment is bright enough or the system detects the headlamps or tail lamps of the vehicle ahead or oncoming vehicles, the system will automatically turn off the main beam.

To enable the automatic high beam system, the following conditions must be met:

- 1 The light lever switch is in the AUTO position and the dipped beam turns on automatically.
- 2 The vehicle is running and the speed is above 25 mph (40 km/h).

INSTRUMENTS AND CONTROLS

3 Rear fog lamps are not switched on.

If the following conditions are met, the vehicle will automatically exit the automatic high beam system. If the system is disabled, pushing the main beam ON switch twice quickly towards the instrument panel can enable the automatic high beam system again. The function can be disabled for three times only in a starting cycle, otherwise it cannot be enabled again in the current starting cycle:

- When the automatic high beam system is enabled and the dipped beam lights are automatically turned on and the lighting system is manually switched to the main beam lights.
- When the automatic high beam system is enabled and the main beam lights are automatically turned on and the lighting system is manually switched to the dipped beam lights.
- When the automatic high beam system is enabled, the main beams are automatically turned on and the main beam flash switch is operated.

IMPORTANT

The Automatic High Beam function uses data from the front view camera, always keep the windscreen clean and free from residue in this area to maintain optimum performance of this system. Any damage in this area, such as stone chips must be repaired at the earliest convenience.

Direction Indicators

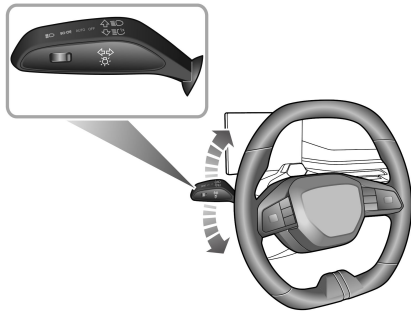

Move the light stalk switch down to indicate a LEFT turn . Move the light stalk switch up to indicate a RIGHT turn. The corresponding GREEN direction indicator in the instrument pack will flash when the turn signal lamps are working. Rotating the steering wheel will cancel the indicator operation (small movements of the steering wheel may not initiate the self cancelling). To indicate

a lane change, move the lever briefly and release, the indicators will flash three times and then cancel.

If the light lever switch is gently moved this will activate the "lane change function". The light lever switch will reset immediately and the direction indicators will flash 3 times.

INSTRUMENTS AND CONTROLS

Rear Fog Lamps



Fog lights should only be used when visibility is below 100m - other road users could be dazzled in clear conditions.

When the vehicle is powered on and the dipped beam lights are active, press the rear fog lamp switch which is located at the top left of the Infotainment screen to switch on the rear fog lamps. The indicator will illuminate on the instrument panel when the rear fog lamps are on .

Hazard Warning Lamps

Press the hazard warning lamps button  , to turn on the hazard warning lamps. At this time, all turn signal lamps and direction indicators will flash together. Press the button again to turn off the hazard warning lamps. All turn signal lamps and direction indicators will stop flashing.

Wipers and Washers

Front Windscreen Wiper and Washer Operation

When the vehicle is powered on, operate the lever switch to select different wiping modes.

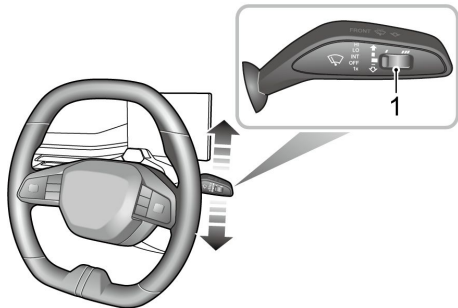

- HI: Fast Speed Wipe
- LO: Slow Speed Wipe
- INT: Automatic Wipe
- OFF: Wiper Off (Default position)

- Ix: Single Wipe

Automatic Wipe

By pushing the lever switch up to the automatic wipe position (INT position as shown), the wipers will operate automatically.

Move the automatic wipe speed adjustment switch (1 as shown) to adjust the automatic wipe speed. This speed also changes with the vehicle speed. As the vehicle speed increases, the wipe interval becomes shorter. As the vehicle speed decreases, the wipe interval becomes longer.

Slow Speed Wipe

By pushing the lever switch up to the slow speed wipe position (LO position as shown), the wipers will operate at slow speed.

Fast Speed Wipe

By pushing the lever switch up to the fast speed wipe position (HI position as shown), the wipers will operate at fast speed.

INSTRUMENTS AND CONTROLS

Single Wipe

By pressing the lever switch down to the single wipe position (1x position as shown) and releasing it, the wipers will perform a single wipe. If the lever switch is held in the single wipe position (1x position as shown), the wipers will operate continuously until it is released.

Note: When the car is stationary, if the bonnet is opened, the front wiper/washer operation will be disabled.

IMPORTANT

- Avoid operating the wipers on a dry windscreen.
- In freezing or extremely hot conditions, make sure that the wiper blades are not frozen or adhered to the windscreen.
- In winter, remove snow or ice from around the wiper arms and blades, including the wiped area of the screen.

Front Windscreen Wash and Wipe

By pulling the lever switch towards the steering wheel, the windscreen washers will operate immediately. After

a short interval, the wipers will commence operating in conjunction with the washers.

Note: The wipers continue operating for three wipes after the lever switch is released. After several seconds, there will be a further wipe to remove any washer fluid from the windscreen.

IMPORTANT

If the washers fail to deliver the screen wash solution (dirt or ice may have blocked the jets), release the lever immediately. This will prevent the wipers from operating, and the consequent risk of visibility being impaired by dirt smearing across the unwashed windscreen.

Steering System

Steering Wheel Position Adjustment



DO NOT attempt to adjust the position of the steering wheel while the car is in motion. This is extremely dangerous.

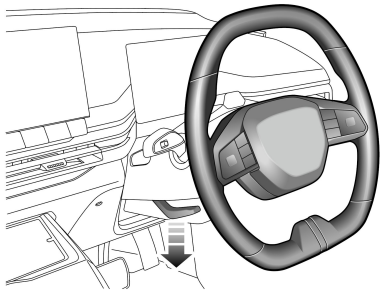

Adjust the steering wheel position to suit your driving posture:

- 1 Fully release the locking lever (as indicated by the arrow).
- 2 Hold the steering wheel in both hands and tilt it up or down to move the wheel into the most comfortable position.
- 3 Push or pull the steering wheel towards or away from the body.
- 4 Once a comfortable driving position has been selected, pull the locking lever fully to lock the steering wheel into its new position.

Electric Power Steering



If the electric power steering fails, the steering may appear very heavy, which will significantly affect driving safety.

The electric power steering system works only when the vehicle is in READY mode. The system operates via a motor with assistance levels automatically adjusted based on vehicle speed, steering wheel torque and steering wheel angle.

INSTRUMENTS AND CONTROLS

IMPORTANT

Holding the steering wheel on full lock for long periods will result in a reduction in power assistance causing a heavier feel to the steering for a short period time.

Steering Mode Switching

The electric power steering system provides 3 different steering modes:

- 1 Normal: provides moderate power assistance.
- 2 Light: provides a high level of assistance, with a light feel.
- 3 Heavy: provides low level power assistance, with a heavier feel.

Please select when stationary via the infotainment system, enter the steering mode screen and select the desired mode.

Horn

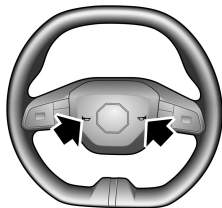

Press the horn button area (as indicated by the arrow) on the steering wheel to operate the horn.

Note: *The vehicle horn button areas and the driver's airbag are located in close proximity on the steering wheel. The illustration shows the position of the horn (indicated by arrow). Please ensure that you press in this area to avoid any potential conflict with the operation of the airbag.*

IMPORTANT

To avoid possible SRS issues, please do not press with excessive force or hit the airbag cover when operating the horn.

INSTRUMENTS AND CONTROLS

Power Socket



Extended use of the accessory power socket and USB socket when the vehicle power system is switched off will cause premature discharging of the vehicle battery.

Front Console Power Socket

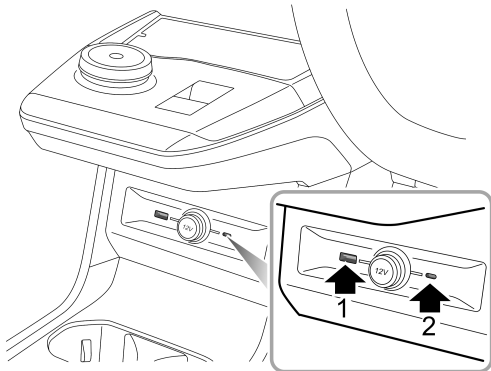

The front power socket is located in the front of the centre console. When the vehicle is powered on, it can be used as a power supply.

There are 2 USB ports (1 & 2) equipped both sides of the 12V front console power socket. The USB ports can provide a 5V voltage when serving as a power outlet, or realize data transmission. USB port 1 can also provide 'Vehicle-Mobile Phone Interconnection' function.

Note: The voltage of the front console power socket is 12 volt, and the power rating is 120 watt. Do Not use electrical equipment with the power exceeding the rating.

Rear USB Port

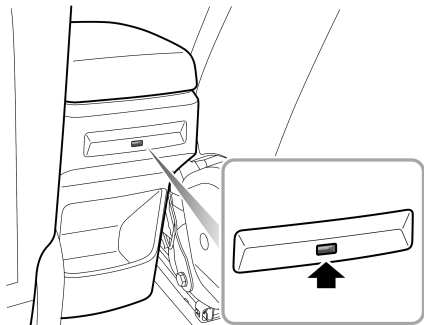

There is a USB port at the rear centre console, which can provide a 5V power source as a power outlet.

Note: *The vehicle's USB ports may not support some fast charging devices.*

INSTRUMENTS AND CONTROLS

Wireless Charging System for Mobile Phones *

The wireless charging function for a mobile phone is realized without the necessity for a connection cable. It is achieved using electromagnetic induction.

Note: *The wireless charging function does not apply to all mobile phones, only brands/models with wireless charging function.*

Wireless Charging of Mobile Phones

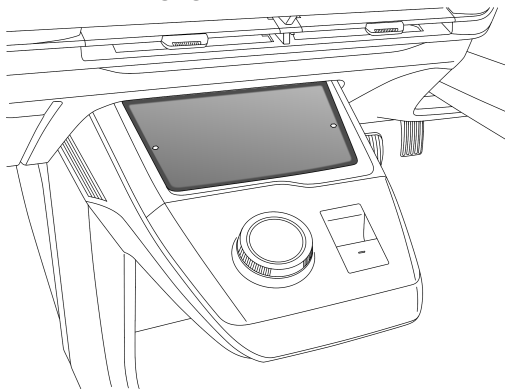

The wireless charging area for mobile phones is located in front of the shift control knob. The charging function is enabled when the vehicle is powered on. Place the phone face up horizontally in the charging area, which can be used for wireless charging.

Note: *Only one mobile phone can be charged at a time.*

Note: *On bumpy roads, the wireless charging function of the mobile phone may intermittently stop and resume. If the mobile phone deviates from the charging area and stops charging, it will need to be placed back in the rechargeable area.*

Note: *The size of each brand of mobile phone is different, and the position of the charging coil on the mobile phone is different. Please adjust the position of the mobile phone accordingly. In addition, the case of some mobile phones may have an impact on wireless charging. It may be necessary to adjust or remove the case to achieve wireless charging.*

If the mobile phone cannot be charged properly, please make sure that there is no foreign matter in the wireless charging area or wait for the wireless charging area to cool down before further attempt. If it still fails, seek a local MG Authorised Repairer.

IMPORTANT

When the wireless charging system of the mobile phone is being used, make sure that the smart key is 20cm or more away from the wireless charging area. Do not place coins, IC cards, metal keys, or other items with a large amount of metal composition in the wireless charging area with your phone. This may result in the failure of wireless charging function and create a safety hazard.

INSTRUMENTS AND CONTROLS

Rearview Mirrors

The rearview mirrors in the vehicle consist of the front door mirrors fitted to each door and the interior mirror mounted in the front of the passenger compartment. Rearview mirrors reflect situations directly behind or below or on both sides of the vehicle thus expanding the driver's field of vision.

The rearview mirrors are safety-critical parts. Proper use and reasonable mirror angle adjustment can improve the driver's driving safety and comfort.

Exterior Rearview Mirrors

The exterior rearview mirrors, as the widest parts mounted on the vehicle, are especially vulnerable in the collision event. The exterior rearview mirrors feature a manual or electric folding function, this helps avoid damage and allows folding when manoeuvring through narrow passages.

In addition to the folding function, each door mirror glass features electric angle adjustment and heating elements, which can effectively remove frost or mist on the mirror.

Note: *Objects viewed in door mirrors may appear further away than they actually are.*

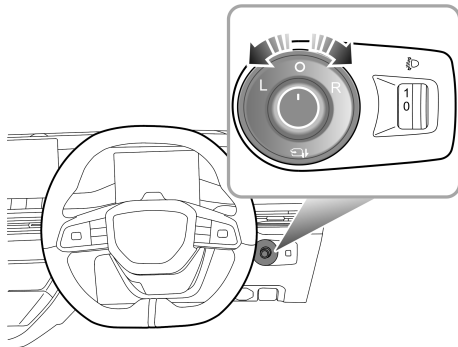

Electric Adjustment of Door Mirror Glass

The exterior rearview mirror glass adjustment switch is located on the instrument panel on the driver's side.

- Rotate the round knob in the middle to select left (L) or right (R) mirror.

- Move the knob in the desired direction to adjust the angle of the exterior mirror glass.

Manual Folding *

For vehicles fitted with the manual door mirror folding option, the exterior mirrors can only be folded backwards manually.

Electric Folding *

When the vehicle is powered on, rotate the round knob to  position, and push the knob down. The door mirrors will be folded automatically. Pushing the knob downwards again will return the mirrors to their original position.

Note: *While unlocking/locking the vehicle, the exterior rearview mirrors will be deployed/folded automatically.*

Note: *Electrical folding door mirrors that have been moved from their positions by manual or accidental means it can be reset by operating the knob to complete fold and deployment one time.*

Mirror Glass Heating

The door mirrors have integral heating elements which disperse ice or mist from the glass.

The heating elements operate while the Heated Rear Window is switched on, that is, only when the vehicle is powered on, and the heated rear window is turned on,  the heating function of the exterior rearview mirrors will work.

Note:

- ***Door mirror glass adjustments are operated by electrical motors. Operating them directly by hand may damage the internal components.***
- ***Washing or flushing door mirrors with high pressure water jets or car washes may result in electrical motor failure.***

INSTRUMENTS AND CONTROLS

Interior Rearview Mirror

Adjust the body of the interior rearview mirror to achieve the best possible view. The anti-dazzle function of the interior rearview mirror helps reduce glare from the headlamps of following vehicles at night.

Automatic Anti-dazzle Interior Rearview Mirror *

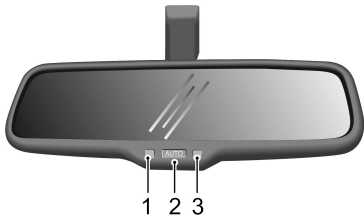

1 Operation Indicator 3 Light Sensor

2 Automatic Anti-dazzle Function Switch

After the car is powered on, the automatic anti-dazzle function is switched on automatically (operation indicator ON). If the system detects a following vehicle where the headlamps may dazzle the driver, the light sensor switches on the anti-dazzle function. Press the automatic anti-dazzle function switch (operation indicator OFF) to switch off the automatic anti-dazzle function, and press it again to re-start this function.

The automatic anti-dazzle function may be impaired or limited in the following situations:

- The lights of the following vehicle are not detected by the light sensor.
- R gear is selected.

Note: *Attaching film on the rear window may have influences on the usage of automatic anti-dazzle function.*

Manual Anti-dazzle Interior Rearview Mirror *



Move the lever at the base of the interior rearview mirror to change its angle, so as to achieve the anti-dazzle function. Normal visibility is restored by pulling the lever back again.

Note: *In some circumstances, the view reflected in a 'dipped' manual mirror can confuse the driver as to the precise location of following vehicles.*

INSTRUMENTS AND CONTROLS

Sunvisor



The vanity mirror on the driver side should only be used when the car is stationary.

front seat is active, serious injury or even death to the child may be caused.

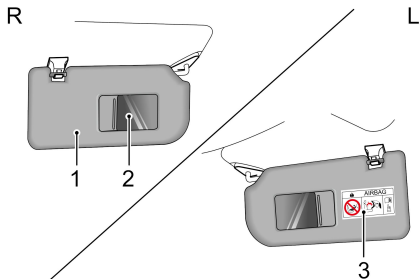

Sunvisor (1) and vanity mirror (2 , optional for some models) are arranged on the roof ahead of both the driver and the front passenger.

A warning label (3) will be provided on each sunvisor to warn the driver and passengers: NEVER use a rearward-facing child restraint when the SRS in the

Windows



Please correctly operate the windows to avoid danger. The driver shall instruct passengers on how to use windows and tell them safety precautions.



Ensure children are kept clear when raising or lowering a window.



DO NOT operate the power window controls continuously several times in a short time frame, otherwise the power window controls may be disabled to protect the motor. If this occurs, please wait a few seconds until the motor cools down. Do not disconnect negative battery during the time.

Power Operated Window Switch

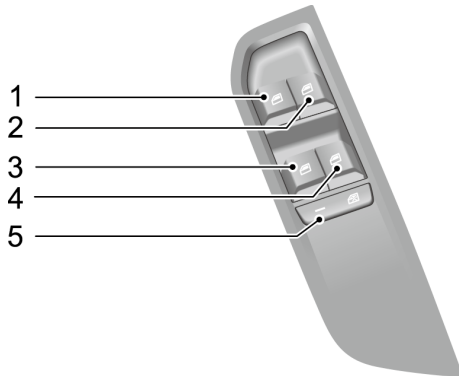

- 1 Front Left Window Switch
- 2 Front Right Window Switch
- 3 Rear Left Window Switch
- 4 Rear Right Window Switch
- 5 Rear Window Isolation Switch

INSTRUMENTS AND CONTROLS

Window Operation

The electric windows can be operated when the vehicle is powered on (Doors should be closed during operation).

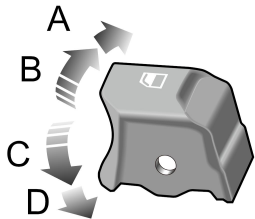

Press the window control switch (1~4) down to the "1" position (Position C) to lower the window, and pull the switch up to the "1" position (Position B) to raise the window. The window will stop moving as soon as the switch is released.

"One-Touch" Down

Press the window control switch 1~4 down to the "2" position (Position D) and release, the window automatically descends to fully open. Window movement

can be stopped at desired position at any time by operating the corresponding switch during descent.

"One-Touch" Up with "Anti-Trap"

Depending on vehicle specification, some windows may have the "One-Touch" up function. Lifting the switch to the "2" position (Position A) for a short time and releasing will automatically close the window completely. Window movement can be stopped at a desired position at any time by briefly operating the switch again. The "Anti-Trap" function is a safety feature which prevents the window from fully closing if an obstruction is sensed -if this happens the window will open slightly to allow the obstruction to be removed.

Note: *The front and rear passenger windows can also be operated by individual window switch mounted on each door. If the rear window isolation switch has been activated, the window switches on rear doors will not work.*

Rear Window Isolation Switch

Press the button (5) to isolate the rear window controls, press again to restore control.

Note: If the battery is disconnected, the “One-Touch” Up and “Anti-Trap” features will be lost. To restore this feature, fully close the window and hold the switch for 5 seconds in the closed position, fully open the window and press the switch for another 5 seconds.

INSTRUMENTS AND CONTROLS

Interior Light

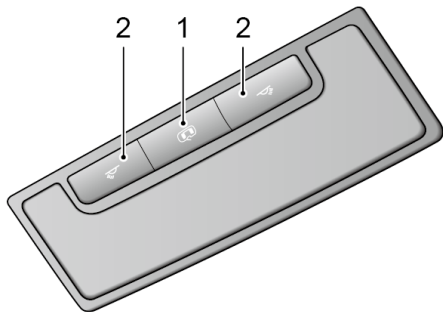

When the automatic operation is enabled, interior lights will illuminate automatically whenever the following occur.

- The car is unlocked.
- Any door is opened.
- When the vehicle equipped with light sensor detects that the ambient light is dark or the side lamp illuminates or turns off for 30 s, it will be powered off.

Note: *Under normal circumstances, if a door or the tailgate is left open for longer than 15 minutes, the interior lights will extinguish automatically. In case of low battery, the interior lights will extinguish quicker.*

Manual Operation

Press one of the switches (2) to turn the corresponding light on, press again to switch off.

Automatic Operation

Press the switch (1) to select front interior lamp automatic operation, press again to turn off the function.

Driver Monitor System

Indirect Driver Fatigue Reminder System *



The driver should always ensure that his/her physical state is suitable for driving even if the vehicle is equipped with an indirect driver fatigue reminder system. NEVER drive the vehicle when fatigued.



The indirect driver fatigue reminder system cannot always identify the driver's fatigue level accurately. It calculates the fatigue level through the driver's operation status instead of monitoring the driver's actual physical characteristics such as distraction, and cannot provide emergency reminder to the driver who has just fallen into fatigue.

The driver attention warning system calculates the driver's fatigue level by comparing information such as vehicle speed and steering wheel angle with basic data obtained based on mass data statistics. The system will constantly compare the calculated fatigue level with the current operation state of the driver. If the system recognizes that

the driver is already in a fatigued state, a warning will be issued.

When the vehicle speed is over 37 mph(60 km/h), the driver attention warning system will operate. When the driver performs the following operations, the system will stop monitoring the driver's fatigue level:

- 1 The driver removes the seat belt and opens the driver door;
- 2 The stop time exceeds 15 minutes;
- 3 The power systems is turned off.

INSTRUMENTS AND CONTROLS

System Settings

The indirect driver fatigue reminder system can be set on the infotainment display.

Note: *The driver attention warning system will not trigger in the following conditions even if it is enabled:*

- *Driving on a continuous curve;*
- *Driving on a poor quality road surface;*
- *Driving on congested roads or roads with lots of traffic lights.*

Direct Driver Monitor System *

The camera of the driver monitor system is located in front of the steering wheel.

Note: *Do not block the camera area, or the system cannot function normally.*

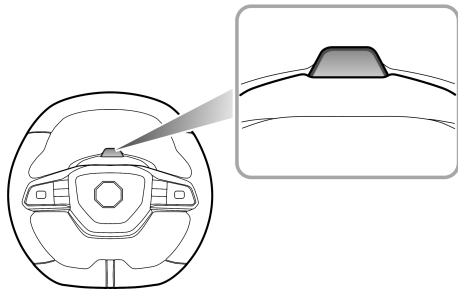

The driver monitor system can identify the driver's fatigue, distraction and other states through the camera, and remind the driver according to the identified fatigue and distraction level.

The driver monitor system can be set on the infotainment display.

INSTRUMENTS AND CONTROLS

Storage Devices

Instructions for Use

- Please close all storage devices when the car is in motion. Leaving these storage devices open may cause personal injury in cases of a sudden start-off, emergency braking and a car accident.
- Do not place flammable materials such as liquid or lighters in any storage devices. The heat in hot conditions may ignite flammable materials and lead to a fire.

Glove Box

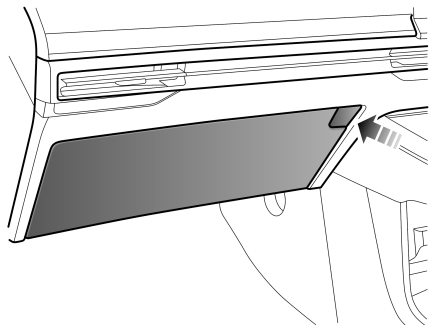

To open the glove box, press the glove box open button (as indicated by the arrow). The glove box light will automatically illuminate.

Push the cover forward to close the glove box. Make sure the glove box is fully closed when the vehicle is being driven.

Storage Box

Centre Console Front Storage Box

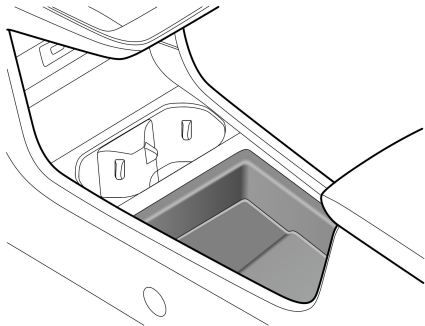

The centre console front storage box is located in front of the centre console armrest box.

Centre Console Rear Storage Box

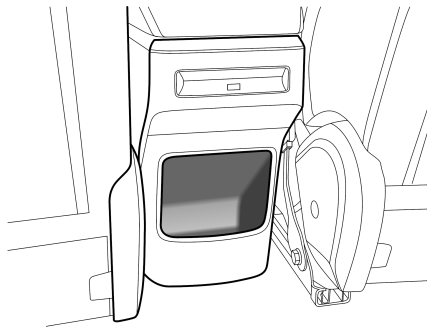

The centre console rear storage box is located at the rear of the centre console.

INSTRUMENTS AND CONTROLS

Centre Console Armrest Box

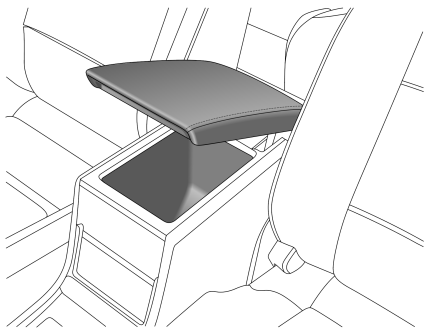

Lift the centre console armrest (as indicated by the arrow) to open the centre console armrest box. Put the centre console armrest down gently to close the centre console armrest box.

Glasses Box



The glasses box should only be used when the vehicle is stationary.

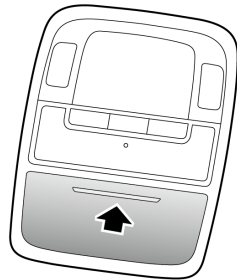

The glasses box is located in the proximity of the front interior lamps. Press the panel (as indicated by the arrow), and place the glasses into the glasses box after opening it. Close the glasses box when it is not in use.

INSTRUMENTS AND CONTROLS

Only glasses with standard frames should be placed in the glasses box.

INSTRUMENTS AND CONTROLS

Cup Holder



DO NOT place hot drinks in the cup holder whilst driving. Spillage may result in personal injury or damage.

Centre Console Cup Holder

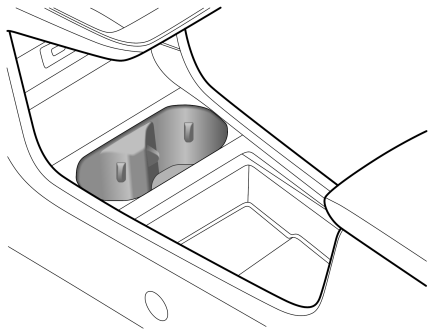

The centre console cup holder is located in front of the centre console armrest assembly, where a cup or beverage bottle can be placed.

Air Conditioning and Audio Systems

84 *Ventilation*

87 *A/C Control Panel*

89 *Air Conditioning Control Interface*

93 *Infotainment System* *

AIR CONDITIONING AND AUDIO SYSTEMS

Ventilation

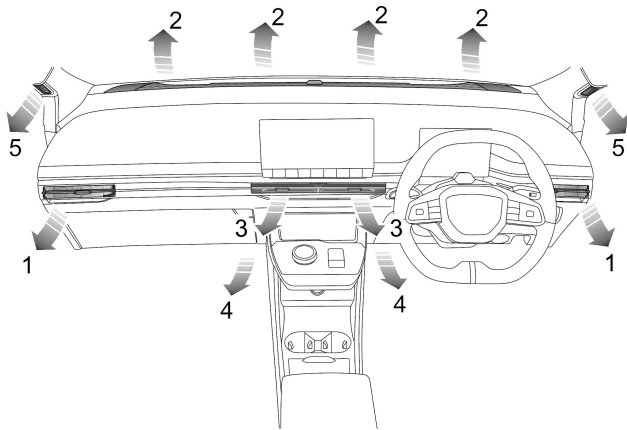

- 1 Side Vents
- 2 Windscreen/Defrost Vents
- 3 Centre Vents
- 4 Front Footwell Vents
- 5 Front Side Window Vents

AIR CONDITIONING AND AUDIO SYSTEMS

The A/C system is used to adjust the temperature, speed, humidity and cleanliness of the air in the vehicle. Fresh air is drawn in through the air intake grille under the windscreen and the A/C filter. Always keep the air intake grille clear of obstructions such as leaves, snow or ice.

A/C Filter

The A/C filter is used to filter the air. To remain fully effective, the filter should be replaced at the recommended service interval.

Vents

Centre Vents Adjustment

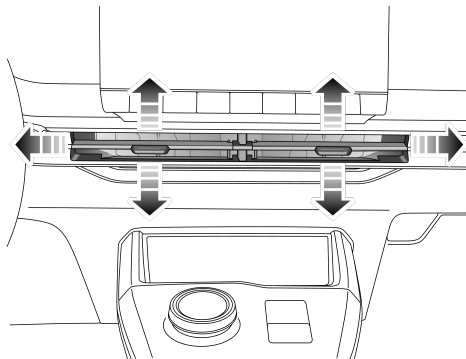

Slide the button in the centre of the louvres completely to the left or right to open or close the vent.

Toggle the button at the centre of each vent up and down, left and right to regulate the air direction.

AIR CONDITIONING AND AUDIO SYSTEMS

Side Vents Adjustment

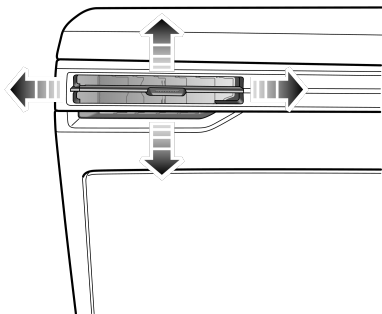

Slide the button in the centre of the louvres completely to the left or right to open or close the vent.

Toggle the button at the centre of each vent up and down, left and right to regulate the air direction.

A/C Control Panel

Control Panel

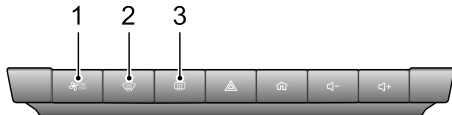

- 1 A/C Control Shortcut
- 2 Defrost/Demist Button
- 3 Heated Rear Window Button

A/C Control Shortcut



Press the A/C Control Shortcut to switch the system on, all functions will revert to the state before shutdown. Press again to switch off.

Defrost/Demist Button



Press Defrost/Demist Button on the control panel, the indicators on the button and display illuminate, the A/C cooling and external circulation functions are switched on, and the system enters the defrost/demist function to clear the windshield and side windows.

Press again to switch off. The indicator will go off and the system will return to the previous state.

Whilst the defrost/demist is selected, operate the A/C on/off button to turn the compressor on/off; operate the air recirculation button to switch between internal recirculation and external circulation; operation of either of these functions will not affect the defrost/demist function; operation of any other air distribution modes will quit defrost/demist.

AIR CONDITIONING AND AUDIO SYSTEMS

Heated Rear Window Button



The heating elements on the inside of the rear window are easily damaged. DO NOT scrape or scratch the inside of the glass. DO NOT stick labels over the heating elements.



Press the Heated Rear Window Button to switch the function on or off. The button indicator illuminates when the function is on, and is extinguished when the function is off. The heated rear window features a timer function and will automatically switch off after a preset time. To continue to use the heated rear window, operate the button again.

Note: *The heated rear window function will only operate when the vehicle is in the READY state.*

AIR CONDITIONING AND AUDIO SYSTEMS

Air Conditioning Control Interface

Air Conditioning Control Interface - Connected Car *

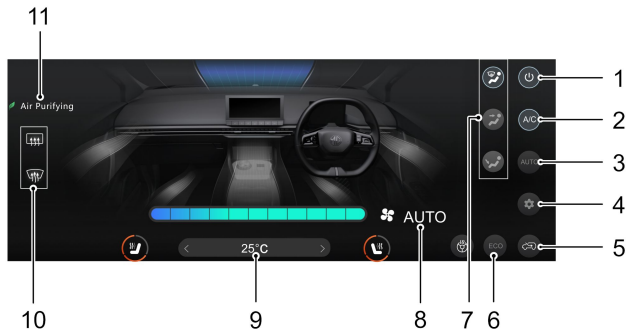

- 1 System On/Off
- 2 Cooling On/Off
- 3 Auto Mode
- 4 A/C Setting
- 5 Air Recirculation Mode
- 6 Economy Mode
- 7 Air Distribution Mode
- 8 Blower Speed Control
- 9 Temperature Control
- 10 Defrost/Demist, Heated Rear Window Display
- 11 Air Purification Mode Display

AIR CONDITIONING AND AUDIO SYSTEMS

System On/Off

Touch the System On/Off Button on the control interface to switch the system on or off.

Cooling On/Off

Touch the A/C Cooling On/Off Touch Button to turn the A/C cooling function ON/OFF.

Note: A small amount of water may remain in the air conditioner after usage, this may produce a peculiar smell. If this is a particular issue, it is recommended to switch off the cooling function and run the blower for a while.

Auto Mode

Set the target temperature required and then press the AUTO touch button to enable the auto mode function. In auto mode, the air distribution mode, blower speed and so on are automatically adjusted to reach and maintain the required temperature.

Manually adjust the air distribution mode or blower speed to exit auto mode. In this case the AUTO indicator will extinguish.

Air Recirculation Mode

Touch the air recirculation mode touch button as needed to adjust the air recirculation mode.



During internal recirculation mode, the A/C system circulates the air inside the vehicle to meet the requirements of rapid cooling or heating, and at the same time, it can prevent the outside dirty air from entering the vehicle.



During the external circulation, the A/C system draws air from outside the vehicle to ensure fresh air enters the vehicle.



During the automatic circulation, the A/C system automatically adjusts the internal or external circulation according to the actual situation.

Note: Leaving the system in internal recirculation mode can cause the windscreen to mist. If this happens, turn on the defrost/demist mode.

AIR CONDITIONING AND AUDIO SYSTEMS

3



Economy Mode





Touch the ECO touch button, the air conditioning system will enter Economy Mode, and the ECO indicator in the button illuminates. In the Economy Mode, the air conditioning system will run at low energy consumption, so as to prolong the driving range.

Note: Selection of the ECO mode will impact situations that require maximum heating or cooling.

Air Distribution Mode

Select the corresponding Air Distribution Mode Touch Button as required to regulate the air distribution mode.

Touch Button	Air Distribution Mode
	Windscreen Mode
	Face Mode

	Feet Mode
	Windscreen and Face Mode
	Windscreen and Feet Mode
	Face and Feet Mode
	Windscreen, Face and Feet Mode

Note: The air distribution mode can also be switched by touching the air outlet area of the control interface.

Windscreen Mode: Directs air to the windscreen/defrost and front side window vents.

Note: In this mode, a small amount of airflow will be directed to the side vents.

AIR CONDITIONING AND AUDIO SYSTEMS

Face Mode: Directs air to the side and centre vents.

Feet Mode: Directs air to the footwell vents.

Note: In this mode, a small amount of airflow will be directed to the side, windscreen/defrost and front side window vents.

Windscreen and Face Mode: Directs air to the windscreen/defrost, front side window, side and centre vents.

Windscreen and Feet Mode: Directs air to the windscreen/defrost, front side window and footwell vents.

Note: In this mode, a small amount of airflow will be directed to the side vents.

Face and Feet Mode: Directs air to the side, centre and footwell vents.

Windscreen, Face and Feet Mode: Directs airflow to the windscreen/defrost, front side window, side, centre and feet vents.

Blower Speed Control

Touch the blower speed control touch button to regulate the blower speed.

Temperature Control

Touch the temperature control touch button to regulate the temperature of the air supplied by the vents.

Infotainment System *

Important Safety Information

- Do not attempt to fit, repair or modify the infotainment system by yourself, because there are high-voltage components in the device, which may cause electric shock. For internal inspection, adjustment or repair, please consult a local MG Authorised Repairer.
- Do not allow this infotainment system to come into contact with liquids and foreign objects. If any of them enter the system by accident, please park your vehicle at a safe place, immediately switch off the power and contact a local MG Authorised Repairer for service. Do not use the infotainment system in this condition because doing so may result in a fire, electric shock, or other failure.
- If you notice smoke, abnormal noises or odours from the infotainment system, or any other abnormal signs on the screen, switch off the power immediately and contact a local MG Authorised Repairer for service. Using this infotainment system in this condition may result in permanent damage to the system.
- Operation of the infotainment system is prohibited whilst the vehicle is in motion, so as to avoid affecting the driving safety due to distractions. Please park your vehicle at a safe location and apply the parking brake before making the necessary adjustments or watching videos.
- Extremely high or low temperatures will interfere with normal operation of the infotainment system. If your vehicle is parked in direct sunlight or in a cold place for a long time, the system may not work properly. Once the temperature inside the car is back to normal, the system will resume normal function. If it does not resume, please contact a local MG Authorised Repairer for service.
- Excessive use of the entertainment and navigation system without the vehicle being driven or in READY mode can drain the vehicle low voltage battery.
- The navigation function of the infotainment and navigation system is only used to assist you in driving. Routes and navigation information displayed in this infotainment and navigation system are for reference only, so the safe driving rules, actual traffic signals and all current traffic laws must always be followed.

AIR CONDITIONING AND AUDIO SYSTEMS

- When using a mobile phone, keep the antenna of the mobile phone away from the screen to prevent the disruption of video signal in the form of spots, colored stripes, etc. on the screen.

Privacy and Data Sharing

When using this infotainment system for the first time, you must read the Privacy Policy carefully and make a choice.

In the settings interface of the infotainment system, you can authorise / disable the data sharing service at any time. Please note that once disabled, the relevant functions will not be available.

Note: Restoring factory settings or upgrading software may require you to reauthorise data sharing services.

Precautions for Screen Usage

- To protect the screen against damage, always touch the screen buttons with your finger (A touch pen may be used for special calibration).

- Please take care to protect the screen against direct sunlight. Extended exposure to direct sunlight will result in screen malfunction due to high temperature.
- When the temperature is beyond the operating temperature range (-30 °C to +85 °C), please do not use the screen, because the screen may not operate normally and could be damaged.
- Do not use excessive force to drag or press the screen, damage or scratching may occur.
- To remove dust from the screen or clean the screen, please turn the system off first, then wipe with a dry soft cloth. When wiping the screen, take care not to scratch the surface. Do not use irritative or abrasive chemical cleaners.

AIR CONDITIONING AND AUDIO SYSTEMS

Basic Operations

Control Panel

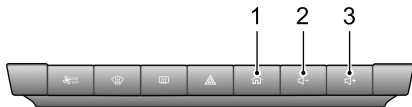

1 (HOME) Button

Short press to return to the main interface; long press to restart the system.

2 Volume Down Button

3 Volume Up Button

Main System Interface

Page one



1 Weather

Touch to enter the weather interface. Please refer to the Infotainment System Manual for details.

2 Energy Management

Touch to enter the Energy Management interface.

3 A/C Display

Displays the temperature and other information. Pull down to enter the A/C interface.

AIR CONDITIONING AND AUDIO SYSTEMS

4 Radio/Music

Touch to enter the Radio/Music interface.





5 Navigation

Touch to enter the Navigation interface. Refer to Infotainment System Manual for details.

6 Status Bar

Displays the signal strength and other information. Pull down to enter the shortcut control screen to set the screen brightness, car control, etc.

7 Shortcut Icons

-  Touch to enter the main system interface.
-  Touch to enter the Navigation interface.
-  Touch to enter the Music interface.
-  Touch to enter the Call interface.
-  Touch to enter the Vehicle Setting interface.

8 Android Auto

Touch to enter the Android Auto interface.

9 Apple CarPlay

Touch to enter the Apple CarPlay interface.

Page Two

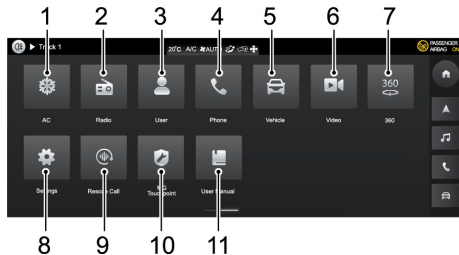

1 A/C

Touch to enter the A/C interface. Refer to "Air Conditioning Control Interface" section in this manual for details.

2 Radio

Touch to enter the Radio interface.

3 User

Touch to enter the User interface.

4 Phone

Touch to enter the Bluetooth Phone interface.

AIR CONDITIONING AND AUDIO SYSTEMS

- 5 Vehicle
Touch to enter the Vehicle Settings interface.
- 6 Video
Touch to enter the Video interface.
- 7 360
Touch to enter the 360 around view system. Refer to the "360 Around View System * " section in this manual for details.
- 8 Settings
Touch to enter the Setting interface.
- 9 Rescue Call
Touch to enter the Rescue Call interface. Please refer to the Infotainment System Manual for details.
- 10 MG Touchpoint
Touch to enter the MG Touchpoint interface.
- 11 User Manual
Touch to enter the User Manual interface.

Power On/Off

Power On

When the vehicle is powered on, the system will automatically turn on.

When the system is on, press and hold the power button on the system control panel for about 10 seconds, the system will restart automatically.

Power Off

When the vehicle is locked, the system will automatically power off.

AIR CONDITIONING AND AUDIO SYSTEMS

Steering Wheel Control Buttons

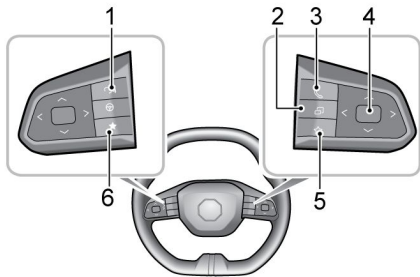

1 Speech Recognition Function Button

Short press to turn on the speech recognition function; short press again to exit the speech recognition function.

2 Infotainment/Instrument Display Button

The function adjustment button is a dual-purpose button, which when pressed will switch control

between the Instrument display and the Infotainment system.

3 Phone Button

Short press to answer an incoming call, Long press to end the call.

4 Function Adjustment Button

When in the infotainment mode: Push up: Volume up; Push down: Volume down; Push to the left: Previous track; Push to the right: Next track; Short press: Mute or Cancel Mute.

When in the A/C mode: Push up, Temperature increases; Push down, Temperature decreases; Push to the left, Blower speed decreases; Push to the right, Blower speed increases; Short press: turn on the AUTO mode.

5 Right Shortcut Button

The user-defined function of the button can be set to AC or SRC in the vehicle settings.

6 Left Shortcut Button

The user-defined function of the button can be set to vehicle control, 360, etc. in the vehicle settings.

Volume Adjustment

- The audio volume can be adjusted using the control panel , the buttons on the steering wheel and the shortcut control page. During volume adjustment, the system automatically pops up a volume indication window which changes smoothly with the adjustment process.

Note: *The playback volume of Bluetooth music can be adjusted by the device itself and the Infotainment player.*

Bluetooth Phone

Instructions for Use

- Connection to all mobile phones featuring Bluetooth wireless technology is not guaranteed.
- The mobile phone used must be compatible with the infotainment system so that all functions of the connected Bluetooth device can function correctly.
- When using Bluetooth wireless technology, the infotainment system may not operate all functions on the mobile phone.
- When transmitting voice and data via Bluetooth technology, the straight-line distance between the infotainment system and the mobile phone should not exceed 10 meters. However, the actual transmission distance may be shorter than the estimated distance, depending on the usage environment.
- When the infotainment system is turned off, the Bluetooth connection will be disconnected.
- Due to Bluetooth wireless connection, interruption or error occurring in the process of transmission in some extreme cases, the infotainment system may be unable to be paired and connected with the mobile phone.

AIR CONDITIONING AND AUDIO SYSTEMS

At this time, it is recommended to clear the paired devices in the device list on the mobile phone and the infotainment system, and conduct pairing again.

Please connect a bluetooth device first before attempting to use any Bluetooth phone functions, Refer to "Bluetooth Pairing and Connection" in "Settings" section for details.

Touch the [Phone] card on the main interface to enter the Bluetooth Phone interface.

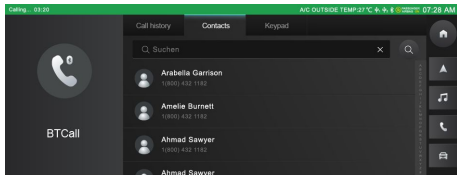

Making a Call

Calls can be made using the following methods:

- Call the number in Contacts.
- Call the number in Call History.
- Keypad input.
- Directly on the mobile phone.

Ending a call

Calls can be ended using the following methods:

- Touch to hang up.
- Long press button on the steering wheel to hang up.
- Hang up on the mobile phone.

Incoming Call

Answer an Incoming Call







- Touch to answer an incoming call.
- Short press button on the steering wheel to answer an incoming call.
- Answer an incoming call on the mobile phone.

Reject an Incoming Call

- Touch to reject an incoming call.
- Long press button on the steering wheel to reject an incoming call.
- Reject an incoming call on the mobile phone.

During a call

During a call,

- Touch  to enter the Private Mode. Touch  to restore the Speaker Mode.
- Touch  to switch to the Microphone mute or Enable function.
- Touch  to enter the Keypad interface.
- Touch  to add a third-party call and maintain the current call. When there are two calls, short press  button on the steering wheel or touch the corresponding Contacts icon to switch the callers (only available when the mobile phone itself supports the three-way calling function).
- Touch  to see the Contacts.

Note: *In the private mode, you may proceed with the call with the mobile phone; the speakers and microphone of the entertainment system will be muted, but Bluetooth is still connected.*

Note: *It is illegal to operate a mobile telephone whilst driving. If you wish to make, or take a call using your mobile phone directly, please ensure you pull over in a suitable location and operate the mobile phone where it is safe and legal to do so.*

Entertainment

Precautions for Playing from a Storage Medium Mode

- The system supports USB drives and Bluetooth storage media.
- If the USB device media is not in use, DO NOT leave the device connected. This may result in connection deterioration.
- Do not remove USB device whilst media is playing. Failure to follow these instructions could result in corrupted data.
- Keep the USB port dry and free from debris. The port will become unusable if it is blocked.
- Due to differences in the compression ratio and bit rate of the multimedia formats downloaded from the Internet and other factors, the actual situation of the decoding result shall prevail.

AIR CONDITIONING AND AUDIO SYSTEMS

Connecting/Disconnecting a USB Storage Device

Inserting a USB Storage Device

Connect a USB device to the USB port for connection.

Removing the USB Storage Device

Check and confirm that there is no data being accessed, then pull out the USB storage device.

Note: If any data loss or breach occurs whilst the USB storage device is inserted or being used, it will generally be unrecoverable. MG Motor accepts no responsibility for any data loss or breach.

Note: Some USB storage devices may be unidentifiable.

Note: The Infotainment system may not achieve its optimum performance when using some USB storage devices.

Note: Using a USB hub or extension cable may result in the USB device not being recognised.

Radio

Touch the [Radio] card in the main interface to enter the Radio interface.

Touch [DAB]/[FM] at the top of the screen to enter DAB or FM Radio interface.

DAB

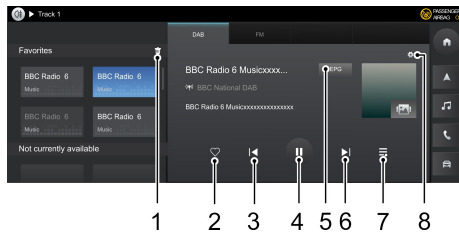

- 1 Click to empty the favorite.
- 2 Add a Station to /Remove a Station from Favorites.
- 3 Previous Station.
- 4 Pause/play.

AIR CONDITIONING AND AUDIO SYSTEMS

- 5 Click to enter the program list.
- 6 Next Station.
- 7 Station list.
- 8 Click to enter the station preferences setting interface.

- 5 Short press to automatically search for the next valid station, and long press for quick FM.
 - 6 Station list.
 - 7 Click to enter the station preferences setting interface.
- Drag  to finely adjust the frequency modulation.

FM



- 1 Click to empty the favorite.
- 2 Add a Station to/Remove a Station from Favorites.
- 3 Short press to automatically search for the previous valid station, and long press for quick FM.
- 4 Pause/play.

AIR CONDITIONING AND AUDIO SYSTEMS

Music

Touch the Radio/Music area in the main interface or  icon to enter the Music interface.

Touch [BT music] / [Online music] / [USB music] on the top of the screen to enter the corresponding music interface. Refer to Infotainment System Manual about the online music for details.

Bluetooth Music

Before playing Bluetooth music, firstly connect the Bluetooth device. Refer to the "Bluetooth Pairing and Connection" in "Settings" section for details.

2 Open/Close Play List.

3 Previous Track.

4 Pause/Play.

5 Next Track.

6 Sound Settings.

Note: Some mobile phones or bluetooth devices may not support synchronized track lists, and the relevant information will not be displayed in the play list bar.

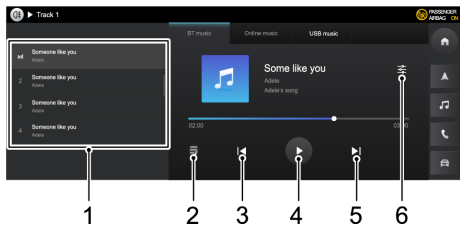

1 Track List.

USB Music

Insert a USB storage device into the USB port, and the system automatically loads the music from the storage device.

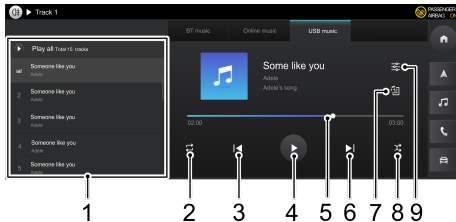

- 1 Track List.
- 2 Single play mode or list play mode.
- 3 Previous Track.
- 4 Play/Pause.
- 5 Drag the progress bar to any playback point.
- 6 Next Track.
- 7 Touch to open the lyrics.

- 8 Random play mode.
- 9 Sound Settings.

AIR CONDITIONING AND AUDIO SYSTEMS

Video

Insert the USB storage device to the USB port. Touch [Video] on the main interface to enter Video Playback interface.

6 Play List.

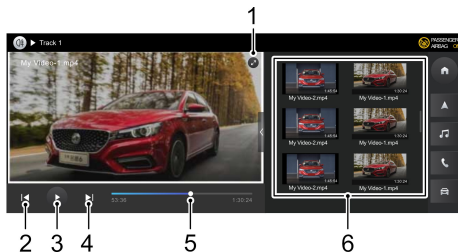

- 1 Touch to switch to full screen playback mode.
- 2 Short press to switch to the previous video, and long press to fast rewind.
- 3 Play/Pause.
- 4 Short press to switch to the next video, and long press to fast forward.
- 5 Drag the progress bar to any playback point.

Vehicle-Mobile Phone Interconnection

Note: *Due to the differences of mobile phone models and system versions, some mobile phones may not be able to use the vehicle-mobile phone interconnection function normally.*

Apple CarPlay

Apple CarPlay enables information interaction between the mobile phone and the on-board infotainment system, including map, music, telephone, voice recognition and so on.

Connection Method

- 1 Confirm that your iPhone has the Carplay function and that it is turned on.
- 2 Connect the mobile phone to the infotainment system mainframe using an approved USB cable.
- 3 In the main interface, touch [Apple CarPlay] area to enter the Apple CarPlay interface.
- 4 After the vehicle and mobile phone are successfully connected, you can operate the iPhone using the infotainment system screen.

- 5 Press the HOME button on the control panel to return to the main system interface.

Android Auto

Android Auto enables information interaction between the android mobile phone and the on-board infotainment system, including map, music, telephone, voice commands and so on.

Ensure the Android Auto software is downloaded to your phone using an APP from your regional APP supplier. Ensure that the function is enabled.

Connection Method

- 1 Connect the mobile phone to the infotainment system using an approved USB cable.
- 2 In the main interface, touch the [Android Auto] area to enter the Android Auto interface.
- 3 Operate according to the interface prompts, you can then use the phone functions once the connection is successful.

AIR CONDITIONING AND AUDIO SYSTEMS

- 4 Press the HOME button on the control panel to return to the main system interface.

MG Touchpoint

Touch [MG Touchpoint] in the main interface to enter the Maintenance interface. You can view the dealer information.

Vehicle Settings

Touch [Vehicle] or  icon on the main interface to enter the Vehicle Setting interface. You can set the MG Pilot, Light, etc.

Settings

Touch [Settings] on the main interface to enter the Settings interface. You can set the general settings, connection methods, traffic management, etc.

General

Touch [General] on the Settings interface to enter the General Settings interface, where you can set the screen brightness, language, and time, etc.

Bluetooth Pairing and Connection

The steps of Bluetooth pairing and connection are as follows:

- Touch [Bluetooth] on the Settings interface to enter the Bluetooth Connection interface, and turn on the Bluetooth switch.
- Vehicle Name: Displays the name of this vehicle. You can customize the name, the name of the vehicle hotspot will be updated synchronously after modification.
- The onboard mainframe will actively search for nearby Bluetooth devices that can be connected and display

them in [Other Devices]. You can also search for this device in your mobile phone for pairing. After pairing, the status bar will display the Bluetooth icon  . If the pairing fails, please repeat the above steps.

The devices already paired and connected are displayed in the [Connected Currently] directory, only one Bluetooth device can be connected to this system.

In the Bluetooth Connection interface, you can choose whether or not to synchronize call history and contacts, disconnect the currently connected device, and pair with other devices in [Pairing history] or [Other devices] according to your requirements.

WiFi Connection

WiFi connection steps are as follows:

- In the settings interface, touch [Wireless network], enter the WIFI connection interface, and turn on the WIFI switch.
- Select the WIFI with which you want to connect in the [Choose the Network] column to connect, or touch [Add network] to connect to a hidden WIFI by entering the WIFI name, security type or password.

Note: For your information security, it is recommended to choose a high security wireless network with security of WPA2.

Hotspot Connection

In the settings interface, touch [Vehicle Hotspot], enter the vehicle hotspot interface, and turn on the Vehicle Hotspot switch.

- Vehicle name: displays the name of this vehicle, you can customize the name, the vehicle name on the vehicle Bluetooth will also be updated synchronously after modification.
- Hotspot Passcode: You can customize the vehicle hotspot password, the length of which must be greater than 8 characters.
- Hotspot network frequency band: 2.4GHz or 5GHz can be selected. 2.4GHz supports more devices connected to the vehicle hotspot, but interference may be easily caused, while 5GHz is the opposite. You can set the network band according to your needs.
- Device Connected: Displays the number of devices connected to the vehicle hotspot and the device information.

AIR CONDITIONING AND AUDIO SYSTEMS

Traffic Management

In the settings interface, touch [Data traffic management] to enter the traffic management interface, you can turn the online network switch on or off and view the traffic usage.

Voice

In the settings interface, touch [Voice] to enter the voice setting interface to set the voice broadcast language, greetings, etc.

Volume setting

In the settings interface, touch [Volume setting] to enter the volume setting interface to set the system sound, chime, etc.

System

In the settings interface, touch [System] to enter the system setting interface. You can view the software version or upgrade the application software.

Touch [Upgrade] to enter the Upgrade interface, and select [Detect New Version]. If the system detects a new version,

you can download and install the new software version according to the interface prompt.

Note: For software version, map and voice upgrade related functions, please contact a local MG Authorised Repairer for more details.

Activate

In the settings interface, touch [Activation] to enter the activation interface. If the activation process has not been completed, you can activate it here.

Privacy Policy

In the settings interface, touch [Privacy policy] to enter the privacy policy interface, where you can view the privacy policy and choose whether to agree with it or not.

Seats and Restraints

112 Seat

118 Seat Belts

*129 Airbag Supplementary Restraint
System*

140 Child Restraints

SEATS AND RESTRAINTS

Seat

Seat Positions and Backrest Angle



To avoid personal injuries due to the loss of vehicle control, DO NOT adjust the seats while the vehicle is in motion.

An ideal position of the seat should make sure your driving position is comfortable, which allows you to hold the steering wheel with your arms and legs slightly bent and control all the equipment.

Do Not incline the front seat backrest excessively. Optimum benefit is obtained from the seat belt with the backrest angle set to approximately 25 ° from the upright (vertical). To reduce the risk of injury from sitting too close to an inflating airbag, the front seats should be positioned as far rearward as practical. Take care when adjusting the height of front seats - the feet of the rear passenger could become trapped when the seat is lowered.

Head Restraints



Adjust the height of the head restraint so that the top of it is in line with the top of the occupant's head. This location may reduce the risk of neck injuries in the event of a collision. DO NOT adjust or remove the head restraints while the car is moving.



Do not hang anything on any head restraint or head restraint rod.

The head restraint is designed to prevent rearward movement of the head in the event of a collision or emergency braking, thereby reducing the risk of head and neck injuries. The height of split type head restraint can be manually adjusted.

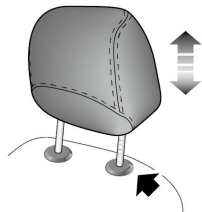

When adjusting a head restraint from low to high position, pull the head restraint directly upward, and gently press it downward after it reaches the desired height to make sure that it is locked in position. To remove the head restraint, press and hold the guide sleeve button (as indicated by the arrow) on the left of the head restraint, then pull the head restraint upward to remove it.

When adjusting a head restraint from high to low position, press the guide sleeve button (as indicated by the arrow) on the left of the head restraint, and press the head restraint downward; release the button after it reaches the desired

SEATS AND RESTRAINTS

height, and gently press the head restraint downward to make sure that it is locked in position.

Front Seats

Note: *The front seat functions of the vehicles are not completely the same depending on the model configurations.*

Manual Adjustment (With the driver side as an example)

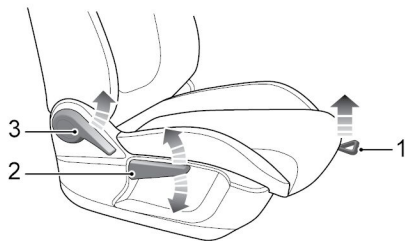

- Forward/Rearward Adjustment

SEATS AND RESTRAINTS

Lift the handle 1 to slide the seat into an appropriate position, and release the handle to make sure that the seat is locked in position.

- **Cushion Height Adjustment ***

Lift the handle 2 repeatedly to raise the seat cushion, and press the handle 2 repeatedly downward to lower the seat cushion.

- **Backrest Angle Adjustment**

Lift the handle 3 to adjust the backrest to an appropriate angle, and release the handle to make sure that the backrest is locked in position.

Electric Adjustment (With the driver side as an example)

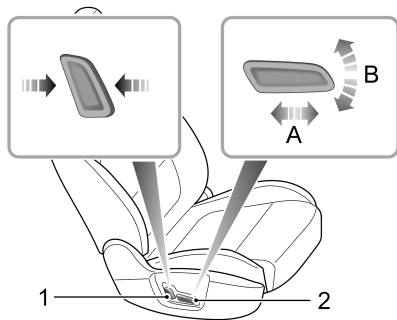

SEATS AND RESTRAINTS

- **Backrest Angle Adjustment**
Move the switch 1 forward/backward to adjust the backrest until it reaches the desired angle.
- **Forward/Rearward Adjustment**
Push the switch 2 along the direction of A to move the seat forward/rearward.
- **Cushion Height Adjustment**
Pull or push the switch 2 along the direction of B to raise or lower the seat cushion.

Rear Seats

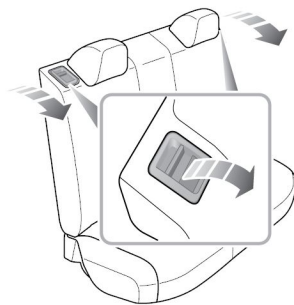

- **Folding Rear Seats**
To increase load space, fully lower (or remove) all head restraints of rear seats, pull up the respective control handles and fold the seat backrest forward.

Note: *If the rear seat head restraints are not fully lowered or the backrest of the front seat is inclined backward excessively, the folding of the rear seat is very likely to damage the back of the front seat, small storage compartment or rear seat head restraint. If the rear seat head restraints are not fully lowered or the backrest of the front seat is inclined backward excessively, the folding of the rear seats is very likely to damage the back of the front seat or rear seat head restraints.*

- **Unfolding and Locking Rear Seat Backrests**

To return the rear seat backrest to an upright position, pull up the backrest control handle to release the lock, raise the rear seat backrest, when the desired upright position is reached, a 'click' will be heard.

Note: *When returning the rear seat backrest to the desired position, make sure that the rear seat belts are not trapped.*

Front Seat Heating Function *



If bare skin is in contact with the heated seats for excessive periods of time, it may cause burns.



The seat heating of this vehicle has three temperature levels, and the seat heating switch is located on the Air Conditioning Control interface of the display. After the vehicle is started, you can enable or disable the seat heating function on the Air Conditioning Control interface of the display, and adjust the heating level. When the cushion temperature reaches approximately 38°C or the backrest temperature reaches approximately 40°C, the heating function will be deactivated automatically.

IMPORTANT

- DO NOT cover the heated seats with blankets, cushions or other insulation type objects or materials.
- If the seat exceeds a certain temperature and continues getting hotter when using the seat heating function, please turn off the seat heater switch and contact a local MG Authorised Repairer.
- Over use of the driver's heated seat may cause drowsiness and could affect safety.

SEATS AND RESTRAINTS

Seat Belts



Incorrectly worn seat belts could cause injury or death in the event of an accident. Seat belts are designed for one person, DO NOT share seat belts.



DO NOT wrap a seat belt around when holding a baby or child in your arms. Remove any heavy coats or clothing when wearing a seat belt, failure to do so can affect protection provided by the seat belt.



Seat belts should not be wrapped around hard or sharp objects such as pens, spectacles or keys.



Seat belts cannot function correctly when the seats are reclined excessively. DO NOT drive when the seats are excessively reclined.



This vehicle is equipped with seat belt warning lamp to remind you to fasten your seat belt. For details,

refer to "Warning Lamps and Indicators" in "Instruments and Controls" section.

While driving, all occupants must fasten their seat belt. Because:

- You can never predict if you will be involved in a collision accident and how serious it may be.
- The seat belts will automatically lock in the event of a collision or emergency braking. The correctly worn seat belt will make the strongest bone in your body bear the impact force, so that you and your vehicle decelerate together to prevent the out-of-control movement which may cause serious injury to the driver and passengers.
- Even in a minor traffic accident, the forces generated by a low-speed collision cannot be supported by your arms and hands.
- The experience has clearly demonstrated that correct wearing of seat belts is closely related to the effective protection of occupants in most collision accidents!

Protection Provided by Seat Belts

Note: It is of equal importance for passengers in the rear seats to fasten their seat belts correctly. Otherwise, passengers with seat belts not correctly fastened will be thrown forward in accidents, and will endanger themselves as well as the driver and other passengers. **NEVER** fasten the driver seat belt or use a buckle replacement when the driver seat is vacant or when exiting the vehicle.

When the vehicle is in motion, the traveling speed of the occupants is identical to that of the vehicle. In the event of a 'head on collision' or emergency braking, the vehicle may stop, but the occupants will carry on traveling until they come into contact with a stationary object. This object may be the steering wheel, dashboard, windscreen and others. A correctly fastened seat belt will eliminate this risk of injury.

When the seat belt is worn correctly, it will lock automatically in collision accidents or emergency braking to reduce your speed together with the vehicle, so as to prevent the out-of-control movement which may cause serious injury to driver and passengers.



SEATS AND RESTRAINTS

Wearing Seat Belts



Incorrectly worn seat belts could cause injury or death in the event of an accident.



Seat belts are designed for one person. DO NOT share seat belts.



DO NOT wrap a seat belt around when holding a baby or child in your arms.



Remove any heavy coats or clothing when wearing a seat belt, failure to do so can affect protection provided by the seat belt.



Seat belts should not be wrapped around hard or sharp objects such as pens, spectacles or keys.



Seat belts cannot function correctly when the seats are reclined excessively. DO NOT drive when the seats are excessively reclined.

The seat belts fitted to your vehicle are designed for use by normal sized adults. This part of the literature refers to adult use. For advice on seat belt use with children, please see "Children and Seat Belts".

In order to maintain effective protection, the passengers must sit in the correct orientation, feet placed on the floor in front of them, with an upright body (no excessive recline) and the seat belt correctly fastened.

Lap and Shoulder Belts

All seat belts are 3-point lap-shoulder belts, which should be used correctly as described below.

- 1 Adjust the seat correctly.
- 2 Hold the metal tab, pull the seat belt out steadily over the shoulder and across your chest. Ensure there is no twist on the belt.

SEATS AND RESTRAINTS

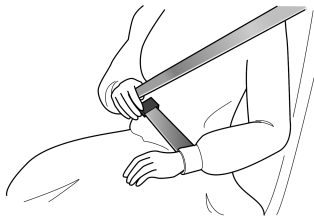

- 3 Insert the metal tab into the buckle until you hear a 'click', this indicates the seat belt is securely locked.

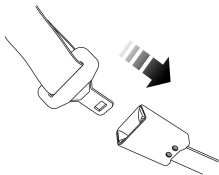

- 4 Remove any slackness in the belt by pulling up on the diagonal section of the belt.

- 5 To release the seat belt, press the red button on the buckle. The seat belt will retract automatically to its original place.

Correct Routing of the Seat Belts



Ensure the seat belt is correctly positioned on the body, NEVER cross the neck or abdomen, NEVER pass the seat belt behind the back or under the arms.

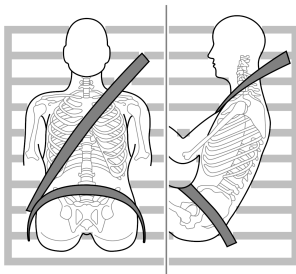

SEATS AND RESTRAINTS

When wearing seat belts, the lap belt section should be positioned as low as possible across your hips, NEVER across the abdomen. In the event of a collision, the lap belt can apply a force on the hips and reduce the possibility of you slipping under the lap belt. If you slip under the lap belt, the belt will apply force on your abdomen, which may cause serious or fatal injuries. The diagonal section of the belt should cross the middle of the shoulder and the chest. In the event of emergency braking or collision, the diagonal section of the belt will be locked.

To ensure that the seat belts always provide maximum protection, ensure the belt is flat, not loose and contacts the body.

Seat Belts Use During Pregnancy

Wearing correctly positioned seat belts will provide protection for both mother and unborn child in the event of a collision or emergency braking. The diagonal section of the seat belt should pass across the chest as normal, the lap section of the belt should pass below the belly, low and snug on the hip bones. NEVER position the belt on or

above the belly. Please consult your physician for further details.



Please consult your physician for further details.

Seat Belts and Disabilities

It is a legal requirement that all occupants wear seat belts, this include people with disabilities.

Depending upon the disability, consult your physician for further details.

Children and Seat Belts



Proper protection measures must be taken for children during driving.

For safety reasons, children must ride in a child restraint fixed to the rear seat.

Infants



Only recommended child restraints suitable for the age, height and weight of the child should be used.



NEVER carry a child or infant with your arms during driving. When collision accidents occur, the weight of the child will produce so great of a force that you will not be able to hold on to the child. The child will be thrown forward and suffer serious injury or even death.

The seat belts fitted to your vehicle are designed for adults, they are not suitable for children. In the event of an

accident or collision the children are not secure, it could cause death or serious injury.

Infants **MUST** use a suitable child restraint device. Please consult the child seat manufacturer's guidelines when selecting the correct seat. Follow the manufacturer's instructions on installation. Please refer to "Child Restraints" in this chapter for more details.

Older Children



NEVER share a seat belt amongst children. In the event of an accident or collision, the children are not secure. It could cause death or serious injury.

SEATS AND RESTRAINTS

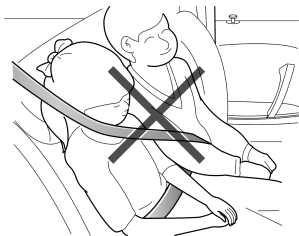

If the shoulder belt is too close to the child's face or neck, it may be necessary to use a child booster cushion (always ensure that it meets any relevant laws or standards).

As children grow and become older/larger, it will get to the stage when they no longer require child seat restraints. At this point they will require use of the vehicle standard seatbelt. Please ensure the seat belt is correctly positioned on the body of the child.

When fastening a seat belt for a child, always check it for correct positioning. Adjust the height of seat belt to ensure the shoulder belt is kept away from the child's face and neck. Position the lap belt across the hips as low as possible, and tighten adequately. Correct positioning means that the seat belts can pass the applied force to the strongest part of the child's body in accidents.

Seat Belt Pre-tensioners



*The seat belt pre-tensioners will only be activated once and then **MUST BE REPLACED**. Failure to replace the pre-tensioners will reduce the efficiency of the vehicle's restraint system.*



*If the pre-tensioners have been activated, the seat belts will still function as restraints, and must be worn in the event that the vehicle remains in a drivable condition. The seat belt pre-tensioners should be replaced at the earliest opportunity by an **MG Authorised Repairer**.*

The vehicle is fitted with seat belt pre-tensioners. These are designed to retract the seat belts and work in conjunction with the airbags in the event of a severe collision. They are designed to retract the seat belt and secure the occupant.

The airbag warning lamp on the instrument pack will alert the driver to any malfunction of the seat belt

pre-tensioners (refer to "Warning Lamps and Indicators" in the "Instruments and Controls" section).

The seat belt pre-tensioners can only be activated once, after activation in a collision they must be replaced. This may also involve replacement of other SRS components. Please refer to "Replacement of SRS Components" in "Airbags" of this chapter.

IMPORTANT

- The removal or replacement of a pre-tensioner must be carried out by the technicians trained by the manufacturer.
- 10 years from the initial date of registration (or installation date of a replacement seat belt pre-tensioner), some components will need to be replaced by an MG Authorised Repairer.

SEATS AND RESTRAINTS

Seat Belt Checks, Maintenance and Replacement

Seat Belt Checks



Split, worn or frayed seat belts may not function correctly in the event of a collision, if there are any signs of damage, replace the belt immediately.



Always ensure the red release button on the seat belt buckle is pointing upwards ensure easy release in the event of an emergency.

Please follow the instructions below to check the seat belt warning lamp, seat belt, metal tab, buckle, retractor and fixing device regularly:

- Fully extract the seat belt and visibly examine for twists, fraying, splits or worn areas.
 - Fully extract the seat belt and allow to return slowly to ensure continual and complete smooth operation.
 - Visibly examine the seat belt system for missing or broken components or components that may affect the normal operation.
 - Check if the seat belt warning lamp functions normally.
- If the seat belt fails any of the above tests or inspections, please contact an MG Authorised Repairer.
- Insert the seat belt metal tab into the corresponding buckle and pull seat belt webbing close to the buckle quickly to check that the belt clasp locks.
 - Hold the metal tab and pull the seat belt forward quickly to check that the seat belt reel locks automatically, preventing the webbing from extending.

Seat Belt Maintenance



DO NOT attempt to remove, install, modify, disassemble or dispose of the seat belts. Have any necessary repairs carried out by your MG Authorised Repairer. Inappropriate handling may lead to incorrect operation.



Ensure no foreign or sharp objects become lodged in the seat belt mechanisms. DO NOT allow liquids to contaminate the seat belt buckle, this could affect the buckle engagement.

Seat belts should only be cleaned with neutral soap and warm water. DO NOT use any solvent to clean the seat belts. DO NOT attempt to bleach or dye the seat belts, or they may be weakened. After cleaning, wipe with a cloth and allow to dry. DO NOT allow the seat belt to fully retract before it is completely dry. Keep seat belts clean and dry.

If there are contaminants accumulated in the retractor, the retraction of the seat belt will be slow. Please use a clean and dry cloth to remove any contaminants.

SEATS AND RESTRAINTS

Replacing Seat Belts



Collision accidents may damage the seat belt system. The seat belt system may not be able to protect users after damage, which may result in serious injury or even death. After an accident, seat belts should be checked and replaced as needed immediately.

Seat belts should not require change after minor collisions, however, some other parts of the seat belt system may require attention. Please consult an MG Authorised Repairer for advice.

Airbag Supplementary Restraint System

Overview



The airbag SRS provides ADDITIONAL protection in a severe frontal impact only. It does not replace the need, or requirement to wear a seat belt.



The airbags together with the seat belts provide optimum protection for adults, but it is not the case for infants. The seat belt and airbag systems in the vehicle are not designed for protecting infants. The protection required by infants should be provided by child restraints.

In the corresponding position where airbags are fitted, there is a warning sign stating " AIRBAG ". The Airbag Supplementary Restraint System generally consists of:

- Front Airbags (fitted to the centre of the steering wheel and dashboard above the glove compartment)

- Seat Side Airbags (fitted to the outer side of the seat backrest cushion)
- Side Head Impact Protection Airbags (fitted behind the headlining)

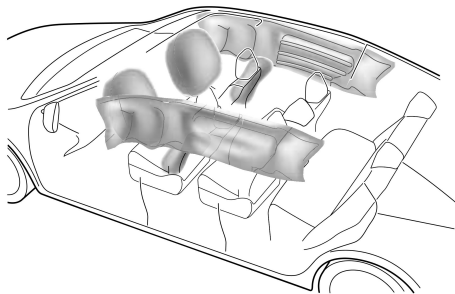

4

Airbag Warning Lamp



The airbag warning light is located in the instrument pack; if this light illuminates while the car

SEATS AND RESTRAINTS

is being driven, it indicates an SRS fault or seat belt pre-tensioner fault has been detected. In this case, please contact an MG Authorised Repairer for service immediately. Otherwise there may be the risk that the SRS or the seat belt pre-tensioner cannot work properly in the event of a collision. The vehicle is equipped with airbag warning lamps to remind you of the status of the vehicle's safety system. For details, refer to "Warning Lamps and Indicators" in "Instruments and Controls" section.

Airbag Deployment



Front seat passengers should not place feet, knees or any other part of the body in contact with, or in close proximity to a front airbag.



To minimise the risk of accidental injury from inflating airbags, seat belts should be worn correctly at all times. In addition, both driver and front passenger should adjust their seat to provide sufficient distance from the frontal airbags, so as to avoid severe or even fatal injury when the airbag is deployed. If side airbags and side head impact protection airbags are fitted, both driver and front seat passenger should be seated to maintain sufficient distance from the upper part of the body to the sides of the vehicle, this will ensure maximum protection when the side airbags/side head impact protection airbags are deployed.



An inflating airbag can cause facial abrasions and other injuries if the occupant is too close to the airbag at the time of its deployment.



When airbags are deployed, children without proper protection may suffer from serious injury or even death. DO NOT carry children in the arms or on the knees during traveling. Children should wear seat belts suitable to age. DO NOT lean out of windows.



After deployment, the relevant components of the airbags will become very hot, such as the steering wheel, instrument panel and both sides of the roof rails. DO NOT touch airbag related components after airbag deployment, it may cause burns or serious injury.

SEATS AND RESTRAINTS



DO NOT knock or strike the position where the related parts of the airbags are located, so as to avoid accidental airbag deployment which may cause serious injury or even death.



The inflation passage of the airbag must be free of any obstructions. Do not place any objects between passengers and airbags. It is prohibited to fix or place any objects on the steering wheel cover, or on/near the airbag cover in the front of the instrument panel. DO NOT place any accessories or decorations around the airbags. This may affect the airbag passage or create projectiles that may cause injury or serious harm in the event of airbag deployment.

In the event of a collision, the airbag control unit monitors the rate of deceleration or acceleration induced by the collision, to determine whether the airbags should be deployed. Airbag deployment is virtually instantaneous and occurs with considerable force, accompanied by a loud noise.

Provided the front seat occupants are correctly seated and with seat belts properly worn, the airbags will provide additional protection to the chest and facial areas in the event of the car receiving a severe frontal impact. Side airbags and side head impact protection airbags are designed to offer additional protection to the side of the body facing the impact, if a severe side collision occurs.

When you sit upright in the seat and against the backrest, seat belts and airbags can provide the most effective protection. When encountering serious collision, airbags will deploy drastically. At this moment, if you or other passengers do not use seat belts properly, and lean forward, recline or sit in other incorrect postures, you or other passengers are likely to suffer from serious injury or fatal injury.

IMPORTANT

- Airbags cannot protect lower body parts of passengers.
- Airbags are not designed for rear collision, minor frontal collision or vehicle overturn; nor will it operate as a result of heavy braking.
- Deployment and retraction of the airbags take place very quickly and will not protect against the secondary impacts that may occur.
- When an airbag inflates, a fine powder is released. This is not an indication of a malfunction. However, the powder may cause irritation to the skin and should be thoroughly flushed from the eyes and any cuts or abrasions of the skin. If skin, eyes, nose, throat, etc. does not feel good, please go to a doctor immediately.
- After inflation, the airbags deflate immediately. This ensures that the driver's vision is not obscured.

Frontal Airbags



NEVER use a rearward facing child restraint on a seat protected by an ACTIVE AIRBAG in front of it, DEATH or SERIOUS INJURY to the CHILD can occur. Refer to 'Disabling the Passenger Airbag'.



Front seat passengers should not place feet, knees or any other part of the body in contact with, or in close proximity to a front airbag.



In extreme cases driving on very uneven surfaces may cause airbag deployment. Please take extra care when driving on uneven roads.

Airbags are designed to deploy during serious impacts, the following conditions may cause airbag deployment.

- A frontal collision with unmovable or non deformable solid objects at a high speed.

SEATS AND RESTRAINTS

- Conditions that can cause serious chassis damage, such as a collision with kerbstones, road edges, deep ravines or holes.

Seat Side Airbags and Side Head Impact Protection Airbags



The structure and material of the seat is critical to the correct operation of side airbags. Therefore, please DO NOT fit seat covers which may affect side airbag deployment.

In the event of a serious side impact, the relevant side airbag will eject from the seat cover and deploy quickly, and the side head impact protection airbag will eject from the roof interior and deploy quickly. The side airbag and side head impact protection airbag at the other side will not deploy. The following or similar conditions may cause the seat side and side head impact protection airbags to deploy.

- One side of the vehicle collides with high-speed ordinary passenger car.

Conditions in Which Airbags Will Not Deploy

The deployment of airbags does not depend on the vehicle speed, but on the object that the vehicle hits, angle of impact and the rate at which the car changes speed as a result of a collision. When the impact force of collision is absorbed or dispersed to vehicle body, airbags may not deploy; however, airbags may sometimes deploy according to impact condition. Therefore, the deployment of airbags shall not be judged based on the severity of vehicle damage.

Frontal Airbags

Under certain conditions the front airbags may not be deployed. Some examples are listed below.

- The impact point is not central to the front of the vehicle.
- The impact is with a solid utility pole or traffic sign post.
- The impact area is high (collision with the tail gate of a higher chassis).
- Frontal collision at an angle with guard bars.
- Impacts to the rear or side of the vehicle.
- The vehicle rolling over.

SEATS AND RESTRAINTS

Seat Side Airbags and Side Head Impact Protection Airbags

Under conditions described below or similar ones, side airbags and side head impact protection airbags may not be deployed.

- Side impacts at certain angles.
- Light side impacts such as a motorcycle.
- The impact point is far away from the center of the vehicle side, such as impact on the side of the engine compartment or loadspace.
- The vehicle rolling over.
- Frontal collision at an angle with guard bars.
- Insufficient side impact force (collision with non-solid objects, such as lamp post or central barrier).
- Insufficient impact force (Collision with parking or moving vehicles).
- The impact is from the rear of the vehicle.

Front Passenger Airbag Switch



This switch can be used to deactivate the front passenger side airbag only when a rearward-facing child restraint is installed on the front passenger side seat.



When an adult is seated in the front passenger side seat, please ensure that the front passenger side airbag is switched on.

The front passenger airbag switch is located on the left instrument panel end cover. To disable or enable the front passenger airbag, insert the mechanical key into the slot and rotate to different positions.

The enabled or disabled status of the front passenger airbag is displayed on the top right of the centre console display



- When the passenger airbag is disabled, the OFF indicator light illuminates.



- When the passenger airbag is enabled, the ON indicator light illuminates for a period of time.

IMPORTANT

- If the OFF and ON indicator lights illuminate together, or the light is inconsistent with the passenger airbag switch position, Please contact an MG Authorised Repairer immediately.

SEATS AND RESTRAINTS

Service and Replacement of Airbags

Service of SRS Components



DO NOT install or modify the airbag. Any changes to the vehicle structure or airbag system wiring harness are strictly prohibited.



Changes to vehicle structure is prohibited. This may affect the normal operation of the SRS.



DO NOT allow these areas to be flooded with liquid and **DO NOT** use petrol, detergent, furniture cream or polishes.



If water contaminates or enters the SRS, it may cause damage and affect deployment. In this case, even if the collision does not occur, the airbag may deploy accidentally. Please shut down the engine and disconnect the battery cable immediately; do not try to start the engine. In this case contact an MG Authorised Repairer immediately.

If the airbag warning lamp fails to illuminate, stays on, or if there is any damage to the front or side of the vehicle, or the airbag covers show signs of damage, contact an MG Authorised Repairer immediately.

IMPORTANT

- The removal or replacement of an airbag module should be carried out by an MG Authorised Repairer.
- After 10 years from the initial date of registration (or installation date of a replacement airbag), some components will need to be replaced by an MG Authorised Repairer.

Replacement of SRS Components



Even if the airbag does not deploy, collisions may cause damage to SRS in the vehicle. Airbags may not function properly after damage, and can not protect you and other passengers when a second collision occurs, which may cause serious injury or even death. To ensure that the SRS can function properly after a collision, please go to an MG Authorised Repairer to check airbags and replace them as necessary.

Airbags are designed for using once only. Once the airbag is deployed, you must replace SRS parts. Please go to an MG Authorised Repairer for replacement.

Disposal of Airbags

When your vehicle is sold, ensure that the new owner knows the vehicle is equipped with airbags, and is aware of the replacement date of SRS. If the vehicle is scrapped, the undeployed airbags may have potential risks, therefore, before the disposal, they must be deployed safely in a

certain environment by a professional agency or an MG Authorised Repairer.

SEATS AND RESTRAINTS

Child Restraints

Important Safety Instructions about Using Child Restraints

It is recommended that children below the age of 12 years old should be seated on the rear seat of the vehicle, in a child restraint system appropriate to the children's weight and size. Infants less than 2 years old should be restrained in an infant child restraint system.

It is recommended that a child restraint system that complies with UN ECE-R 44 or ECE-R 129 standard are fitted in this vehicle. Check markings on the child restraint system.

There are a number of child restraint systems available of different type and specification. For optimum protection, it is recommended that you choose restraint systems appropriate to the child's age and weight.

It is important to comply with installation instructions supplied by the child restraint manufacturer and that any child restraint system is properly secured to the vehicle. Failure to follow these instructions may cause death or

serious injury to the child in an event of a sudden stop or accident.

The correct use of child restraints will greatly reduce children's injury risk in accidents or relieve their injury severity. Please pay attention to the following when you use child restraints:

- All children must use an appropriate child restraint.
- It is recommended that children under 12 years of age or less than 1.5 metres tall should use the appropriate child restraint fitted to the rear seat.
- NEVER let your children ride without protection. Care should not be neglected because of children sitting on the child restraint.
- Only one child can be carried in each child restraint.
- DO NOT put the child on the lap or in arms when sitting in any seat.
- Proper child restraint can provide protection for your children.
- Always adjust the second-row seat back rest to a central position and ensure it is locked in position when installing a child seat or restraint.

- If installing a rear facing child restraint to the rear seat, the corresponding front seat should be adjusted forward; if installing a forward facing child restraint to the rear seat, you may need to adjust the height of the headrest to the lowest.
- If installing a forward facing child restraint to the front seat, you may need to remove its headrest.
- NEVER let your child stand or kneel on the seat during driving.
- Always ensure the child is seated correctly in the child restraint.
- The ways of using seat belts have a great influence on the maximum protection offered by the seat belt, you must comply with the child restraint manufacturer's instructions on proper use of seat belts. If seat belts are not properly fastened, a minor traffic accident may also lead to injury.
- Child restraints that are not fitted correctly may move and injure other occupants in the event of an accident or emergency braking. Therefore, even if there is no infant or child in the child restraint, it also should be fitted properly and securely in the vehicle.

SEATS AND RESTRAINTS

Warnings and Instructions on Use of Child Restraint on Front Passenger Seat



NEVER use a rearward facing child restraint on the front passenger seat with the front passenger airbag activated, otherwise DEATH or SERIOUS INJURY to the CHILD may occur.



Use one child restraint per child.



In cases where there is a need to install a rear facing child restraint on the front passenger seat, use the key to deactivate the front passenger airbag function, or severe injury or even death can occur.



Once the child restraint is removed from the front passenger seat, use the key to reactivate the front passenger airbag.



When installing a child restraint on the front passenger seat, move the front passenger seat as far rearward as possible.

Please study the safety warning label on the sun visor. Where possible always install child restraints on the rear seat. If it is necessary to install a child restraint on the front seat please observe the warnings above.

Important Instructions on Children's Safety and Side Airbags



Children should not be allowed in areas where side airbags may be deployed, there is a risk of serious injury.



Only recommended child restraints suitable for the age, height and weight of the child should be used and firmly fixed in the vehicle.



DO NOT place any items in areas where side airbags may be deployed, there is a risk of serious injury.

In the event of a side collision, the side airbags can provide better protection for the passenger. However, when the airbag is triggered, a very strong expansion force is generated, if the passenger's seating position is not correct, the airbags or items in the side airbag deployment area may cause injury.

When the correct child restraint is used to secure the child properly in the rear seat and the child's seating

position is correct, there is enough space between the child and the side airbag deployment region for the airbag to deploy without any hindrance, and thus provide the best protection.

SEATS AND RESTRAINTS

Fixing Child Restraints

Secured Using 3 Point Lap and Shoulder Belts



Please DO NOT put the rearward facing child restraint on the front passenger seat with the front passenger airbag activated, this may cause serious injury or even death.

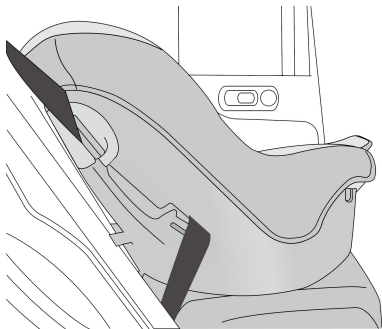

It is recommended that children should always be seated in the rear of the vehicle in a child restraint or restraint system and fixed with 3 point, lap diagonal seat belts.

ISOFIX Child Restraint Systems



The ISOFIX anchorages in the rear seat are designed for use with ISOFIX systems only.



Child restraint anchorages are designed to withstand only those loads imposed by correctly fitted child restraints. Under no circumstances are they to be used for adult seat belts, harnesses, or for attaching other items or equipment to the vehicle.

When installing and using any child restraint system, always follow the child restraint manufacturer's instructions.

The rear seats fitted to this vehicle are provided with the ISOFIX interface (as indicated by the arrow in the following image), these are designed to connect to an ISOFIX child seat.



- Remove the fabric cover to reveal ISOFIX mounting brackets.
- Fasten vehicle-approved ISOFIX child restraint systems to the mounting brackets.
- When using ISOFIX mounting brackets for seat mounting, universally approved child restraint systems for ISOFIX may be used.

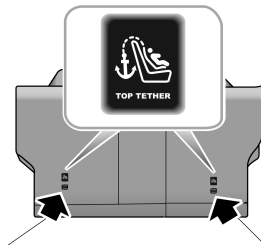

- To fasten the top tether strap of the child restraint system, route the tether strap under the head restraint and attach to the anchorage hook, being careful not to twist the strap. If not using ISOFIX lower anchorages, using the seatbelt, complete the installation in line with the child restraint manufacturers instructions.

Note: When using seat mounting, universally approved child restraint systems, the top tether must be used.

SEATS AND RESTRAINTS

- After installation apply suitable force to the child restraint to ensure the restraint is securely fastened.

Approved Child Restraint Positions

It is recommended that a child restraint system that complies with UN ECE-R44 or ECE-R129 standard are fitted in this vehicle. Check markings on the child restraint system.

Approved Child Restraint Positions (for non ISOFIX Child Restraints)

Mass Group	Seating Positions			
	Front Passenger (Airbag Activated)	Front Passenger (Airbag Deactivated)	Second-row Outboard	Second-row Centre
0 group (less than 10 kg)	X	U	U	U
0+ group (less than 13 kg)	X	U	U	U
I group (9 18 kg)	X	U ¹	U ¹	U ¹
II group (15 25 kg)	U ^{1, 2}	U ^{1, 2}	U ¹	U ¹
III group (22 36 kg)	U ^{1, 2}	U ^{1, 2}	U ¹	U ¹

Note: Description of letters in the table: U = Suitable for universal child restraint systems approved for this mass group; X = Seat position not suitable for child restraint systems in this mass group.

SEATS AND RESTRAINTS

¹ Please remove the head restraint or adjust the head restraint to the highest position if the head restraint affects the installation of child restraint, ensure all removed head restraints are stowed safely.

² Please put the front passenger seat at fully rearward position.

Approved Child Restraint Positions (for ISOFIX Child Restraints)

Securing Position		Children Mass Group					
		0 group	0+ group	I group ¹		II group ¹	III group _i
		Rearward facing		Forward facing	Rearward facing	Forward facing	Forward facing
		Up to 13 kg		9~18 kg		15~25 kg	22~36 kg
Front Passenger	Size Class	No ISOFIX equipped					
	Child Restraint Type						
ISOFIX on both sides of second row	Size Class	C , D , E ²	A , B , BI ²	C , D ²	—	—	
	Child Restraint Type	IL	IL , IUF	IL	IL	IL	

SEATS AND RESTRAINTS

Securing Position		Children Mass Group					
		0 group	0+ group	I group ¹		II group ¹	III group _i
		Rearward facing		Forward facing	Rearward facing	Forward facing	Forward facing
		Up to 13 kg		9~18 kg		15~25 kg	22~36 kg
Second-row Centre	Size Class	No ISOFIX equipped					
	Child Restraint Type						

Note: IL = suitable for particular ISOFIX child restraints of the semi-universal category. Please refer to the vehicle list recommended by child restraints manufacturer;

IUF = suitable for forward-facing ISOFIX child restraints of universal category approved for use in this mass group and ISOFIX size class;

¹ Please remove the head restraint or adjust the head restraint to the highest position if the head restraint affects the installation of child restraint, ensure all removed head restraints are stowed safely.

² The ISOFIX size class for both universal and semi-universal child restraints is defined by the capital letters grade A to G . These identification letters are displayed on the ISOFIX child restraints;

SEATS AND RESTRAINTS

I-Size Child Restraint Table

This table gives recommendations on the mounting position of the I-Size child restraints and the suitability for the corresponding child size.

Child Restraint Type	Front Passenger Seat	Rear Outboard	Rear Middle
I- Size Child Restraint	X	I-U	X
Booster Seat	X	I-B	X

Note: I-U = Suitable for forward-facing or rearward-facing I- Size child restraints;

I-B = Suitable for the following conditions: Forward-facing II/III group ISOFIX Booster seats, and forward-facing I- Size child restraints for children of 100-150 cm (approximately 39-59 inches) tall;

X = Not suitable for I- Size child restraints.

Note:

Britax Baby Safe is recommended for a 1.5 years old child and Duo Plus is recommended for a 3 years old child. Kidfix III S is recommended for a 6 years old child. The lap belt guide (secure guard) and the side impact extensions should be used. The side impact extensions should be extended to the outermost when in use. Nania Dream is recommended for a 10 years old child.

SEATS AND RESTRAINTS

0/0+ group child restraints



Never place a rearward facing child restraint on the front passenger seat with the front passenger airbag activated.

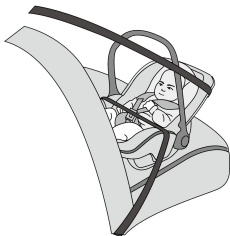

Child restraints that can be adjusted to lying position are most suitable for infants who are lighter than 10 kg (normally for those younger than 9 months) or those who are lighter than 13 kg (normally for those younger than 24 months).

Group I Child Restraint



Never place a rearward facing child restraint on the front passenger seat with the front passenger airbag activated.



Rearward or forward facing child restraints are most suitable for infants whose weight is 9 ~ 18 kg (normally for those older than 9 months and younger than 4 years old).

SEATS AND RESTRAINTS

Group II Child Restraint



The diagonal section of the seat belt should pass across the shoulder and upper body, away from the neck. The lap section of the belt should pass across the hips, away from the abdomen.



The combination of child restraint and 3 point lap and shoulder belts is most suitable for children whose weight is 15 ~ 25 kg (normally for those older than 3 years old and younger than 7 years old).

Group III Child Restraint



The diagonal section of the seat belt should pass across the shoulder and upper body, away from the neck. The lap section of the belt should pass across the hips, away from the abdomen.



The combination of child booster seat and 3 point lap and shoulder belt is most suitable for children whose weight is 22 ~ 36 kg and whose height is below 1.5 m (normally for those about 7 years old or older than 7 years old).

Starting & Driving

- | | |
|---|---|
| <i>154 Keys</i> | <i>238 Tyre Pressure Monitoring System (TPMS)</i> |
| <i>158 Child Proof Locks</i> | |
| <i>159 Starting and Stopping the Power System</i> | <i>240 Load Carrying</i> |
| <i>161 Economical and Environmental Driving</i> | <i>243 Alarm System</i> |
| <i>164 Charging and Discharging Requirements</i> | |
| <i>182 Pedestrian Alert System</i> | |
| <i>183 Electric Drive Transmission</i> | |
| <i>189 Brake System</i> | |
| <i>199 Adaptive Cruise Control System</i> | |
| <i>207 Driving Assist System</i> | |
| <i>227 Parking Aid</i> | |
| <i>230 Rear Driving Assistance System *</i> | |

STARTING & DRIVING

Keys

Overview



Please keep the spare key in a safe place - not in the car!



It is recommended that spare keys are not kept on the same key ring, since this may cause interference and prevent correct key recognition and therefore prevent the correct operation of the vehicle power system.



The smart key contains delicate circuits and must be protected from impact, high temperature, humidity, direct sunlight and fluid corrosion.

We provide two smart keys to you, and each one includes a backup mechanical key. It can be used to mechanically unlock the doors in an emergency, but it cannot be used to start the vehicle.

The smart keys provided to you have been programmed to the security system on your vehicle, any key that is not programmed to the car will not operate the keyless entry function or the vehicle immobiliser.

The smart key only works within a certain range. It's working range is sometimes influenced by the key battery condition, physical and geographical factors. For safety consideration, after you lock your vehicle by the smart key, please recheck if the vehicle is locked..

Keys

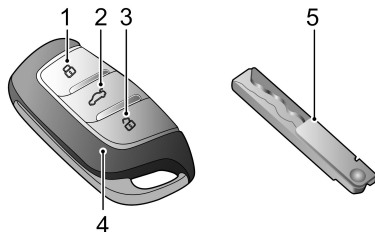

I Lock Button

- 2 Tailgate Button
- 3 Unlock Button
- 4 Smart Key
- 5 Mechanical Key

If your key is lost/stolen or broken, a replacement can be obtained from an MG Authorised Repairer. The lost/stolen key can be deactivated. If the lost key is found, an MG Authorised Repairer can reactivate it.

Note: *Any key made privately may not start the vehicle, and may affect the safety of your car. To obtain a suitable key replacement, it is recommended that you can consult an MG Authorised Repairer.*

Note: *The new key cannot be offered to you immediately because it requires programming to the vehicle by the MG Authorised Repairer.*

Note: *If your car is equipped with induction-type wireless charging function, always keep the key more than 20 cm away from the mobile phone which is being charged to prevent the key from the interference of wireless charging device.*

Note: *Avoid operating the smart key close to strong radio interference devices (such as notebook computers and other electronic products), the normal function of the key may be affected.*

Replacing the Smart Key Battery

Please replace the smart key battery if any of the following conditions occur:

- The locking/unlocking function range of the smart key is obviously reduced;
- "Key Battery Low, Please Replace" is shown on the integrated display

STARTING & DRIVING

A



B



C



D



- 1 Press the button (A) on the smart key to eject the decorative sheet.
- 2 Remove the backup mechanical key (B) in the arrowed direction.
- 3 Using a suitable flat bladed tool, insert the tool into the side of the key (C), carefully prise off the battery cover and separate the upper and lower casings (D).

Note: Make sure that the polarity of battery is correct ('+' side facing down).

Note: It is recommended to use a CR2032 battery.

- 4 Remove the old battery from the slot.
- 5 Put the new battery in the slot, and make sure it is in full contact with the slot.
- 6 Refit the cover and press tightly, ensuring the gap around the cover is even.
- 7 Refit the mechanical key, and close the decorative trim.
- 8 Operate the vehicle power system to resynchronize the key with the vehicle.

IMPORTANT

- Use of an incorrect or inappropriate battery may damage the smart key. The new replacement's rated voltage, sizes and specifications must be the same as the old one.
- Incorrect fitting of the battery may damage the key.
- Disposal of the used battery must be strictly in accordance with relevant environmental protection acts.

STARTING & DRIVING

Child Proof Locks



NEVER leave children unsupervised in the car.

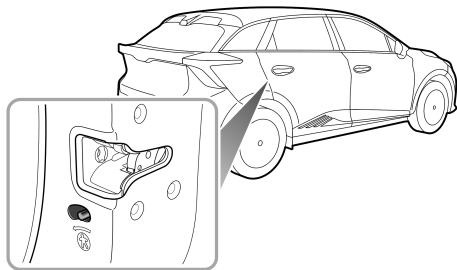

- Move the lever to the unlock position in the reverse direction of the arrow to disable the child proof lock. With the child proof lock locked, the rear door on the corresponding side cannot be opened from inside the car, but can be opened from outside the car.

Steps for enabling or disabling the child proof locks are as follows:

- Open the rear door on the corresponding side, move the child proof lock lever to the lock position in the direction of the arrow to engage the child proof lock;

Starting and Stopping the Power System

Starting the Power System

Starting Procedure

When you open the driver door and sit on the driver seat, the instrument panel and touch screen will be powered on. The door opening and closing status, battery level and other information will be displayed on the instrument panel.

- 1 Depress the brake pedal to enter the READY MODE ;
- 2 Select D gear, or shift into R gear to reverse.

Note: *If the steering wheel cannot be turned after the vehicle has entered "READY MODE", please exit the vehicle ensuring the drivers door is fully closed. Once out of the vehicle, please sit back in the drivers seat and place the vehicle in "READY MODE" as described in the "Starting Procedure Section"*

Alternative Starting Procedure

If the vehicle is located in an area where there are strong radio signals causing interference or the smart key battery

condition is low, please use the following steps to attempt to start the car:

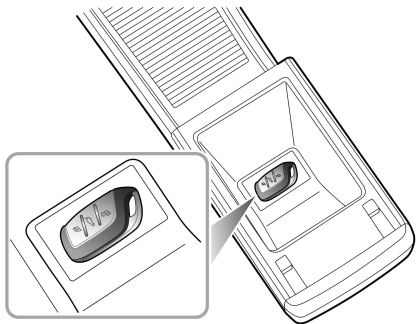

- 1 Place the smart key in the position with the buttons facing upward - as shown in the illustration.
- 2 Place the shift lever in P gear, depress the brake pedal and start the power system.

If the vehicle power system cannot be changed after the car has left the area of strong radio interference or had

STARTING & DRIVING

the smart key battery replaced please consult an MG Authorised Repairer.

IMPORTANT

- If the vehicle fails to entry "READY MODE" for 3 consecutive times, please contact your MG Authorised Repairer.
- The vehicle is fitted with an anti-theft system. Any independently made key cannot start the vehicle.
- In the environment with a temperature of - 10 °C and below, the time required for starting a power system will increase. It is essential that all unnecessary electrical equipment is switched off.

Switching the Power System OFF

Setting the power system to OFF:

- 1 After bringing the car to a halt, always maintain brake pedal application.
- 2 Using the electronic shift control knob select P this will automatically apply the parking brake - please check that the parking brake is applied gear;

- 3 After leaving the driver seat with the key, press the lock button on the remote key (Refer to "Keys" in this section) to power off.

Note: *When you are sitting in the driver's seat, you can still power off the vehicle by clicking the  icon on the large screen and selecting "Safety - Power Off". If you depress the brake pedal, the vehicle will restart.*

Note: *Please observe the park brake warning light and message displayed in the instrument pack message centre confirming that the parking brake is applied before exiting the vehicle.*

Economical and Environmental Driving

Running-in

The brakes and tyres need time to 'bed-in' and adjust to the demands of everyday motoring. During the first 1500 km, please avoid heavy braking where possible.

Economic Driving

The way in which you drive your car has a significant bearing on the life span of the car and battery.

Drive Smoothly

Anticipating obstructions and slowing down well in advance, avoids the need for unnecessary acceleration and harsh braking. A smooth driving style not only improves battery/distance performance, but can reduce the amount of wear on the brakes and tyres.

Avoid Driving at Maximum Speed

Power consumption and noise levels rise significantly at higher speeds.

Driving Foreseeingly

Avoid roads with traffic congestion or traffic jams. Foresee road congestion as early as possible, keep enough distance from the car in front during driving, and slow down in time. Avoid lengthy and heavy brake pedal applications when they are not necessary, these will cause the brakes to overheat and cause premature brake wear.

STARTING & DRIVING

Use of Electrical Equipment

Use of electrical equipment will reduce the power available from the battery. Whilst it is essential to maintain a comfortable interior environment, excessive use of system such as A/C will increase power consumption and reduce the vehicle range.

Driving in Special Environment

Driving in Rain or Snow



Emergency braking, accelerating and steering on slippery roads will reduce the vehicle's handling performance and grip.

- When raining the windows may fog, reducing visibility (Use the Air-conditioning demist function).
- Grip will be reduced, so please drive carefully.
- Reduce speed when it rains. Avoid aquaplaning (the effect of a film of water between the tyres and the road) affecting steering and braking performance.

Driving through Water

Avoid driving through floods after heavy rain, which may lead to serious damage to the vehicle.

Check and Service

Check Tyre Pressures Regularly

Under-inflated tyres increase the rolling resistance of the car which, in turn, increases power consumption. Over or under-inflated tyres wear out more rapidly and also have a detrimental effect on the car's handling characteristics.

Do not Carry Unnecessary Loads

The additional weight of unnecessary loads wastes power, especially in stop/start conditions where the car is frequently required to set off from stationary.

Maintain Correct Four-Wheel Alignment

Maintain the correct wheel alignment. Avoid collisions with the kerb and reduce speed on uneven road surfaces. Out of specification wheel alignment will not only lead to excessive tyre wear, but also increases the load and power consumption.

STARTING & DRIVING

Charging and Discharging Requirements



Under normal circumstances it is strongly recommended that you use a slow charging method, avoid constant or regular use of rapid chargers.



Prior to using any charging equipment please inspect the sockets, plugs and cables for any damage. DO NOT use any equipment that shows signs of misuse or damage.



It is recommended that the charging cable be connected to the charging device before connecting to the vehicle and charging commences.



DO NOT attempt to switch the vehicle power system to READY during charging.



After charging completion, switch off the charger (where necessary), disconnect the cable from the vehicle, fit the waterproof blanking plugs, close the charging point door. If necessary you can then disconnect the cable from the charger (where applicable).



Whilst charging the car on rainy days, where possible, please avoid connecting the charger during torrential rain or storms. If excessive water is evident around the charging plugs please use a suitable cloth to dry the area as best possible before removing the waterproof blanking plugs and connecting the charging cables.



DO NOT touch the charging connector or charging plug when your hand is wet.



DO NOT stand in water or snow when connecting or disconnecting the charging cable.



DO NOT attempt to charge when the charging connector and plug are wet.



Always keep the charging connector and charging plug in clean and in a dry condition. Be sure to keep the charging cable in a condition where there is no water or moisture.



Only use the correct charger for charging the electric vehicle. Using any other charger or connector configuration may cause failure.



Take care not to drop the charging connector. This could result in damage.



STOP charging or discharging immediately if you find anything abnormal, such as sparks, burning or smoke.



Always hold the charging connector handle or plug when connecting or removing the charging cable, if you pull the cable itself (without using the handle), the internal wires may disconnect or get damaged. This may lead to electric shock or fire.



High voltage charging or discharging equipment can cause interference with electronic medical devices. When using medical electrical devices such as pacemakers, please consult your doctor about whether charging or discharging your electric vehicle will impact the operation of the device. In some instances, electromagnetic waves that are generated from the charger can seriously impact medical electric device operation.



NEVER use a high powered jet wash directly on the charger door or to clean around the charge point.

STARTING & DRIVING

Charging Your Vehicle at Home

Whilst your MG has been supplied with an emergency home charging kit, it is essential that you check with a qualified electrician that the infrastructure of your property will support the charging equipment. Please seek qualified advice that your current electrical supply and circuits will support the requirements of the charging equipment.

Installed Charging Points

Various companies will supply and install charging points to your property, MG insist that only qualified reputable suppliers and installers are used - failure to have the correct equipment installed by a qualified professional may result in overloaded circuits and fire.

Home Charging Guide

ONLY use certified approved equipment.

ONLY use qualified suppliers and installers.

When the battery is fully charged, disconnect the cable plug from the vehicle socket - if it is necessary to interrupt the

charging of the vehicle, isolate the power supply first, then disconnect the vehicle plug.

NEVER allow water or fluids to enter or contaminate your charger or vehicle charging sockets.

NEVER use damaged charging points, equipment or sockets.

STOP charging immediately if you see anything unusual, smell something burning or see sparks.

ALWAYS follow the operating instructions supplied with your charging equipment.

Note: The charging point and power supply infrastructure must be installed and serviced by suitable qualified personnel from an approved installation company using only the materials recommended by them.

Charging and Medical Condition Awareness



High voltage charging equipment can create areas of strong electromagnetic interference, this may cause operational issues with electronic medical devices.

When using medical electrical devices such as pacemakers or cardioverter defibrillators (ICD's), please consult your doctor about whether charging or discharging your electric vehicle will have an impact on the operation of the device. In some instances, electromagnetic waves that are generated from the charger can seriously impact medical electric device operation.

Note: There are no cautions issued about medical devices when the car is not charging or discharging. It is perfectly safe for individuals fitted with pacemakers or cardioverter defibrillators to drive or ride in the vehicle.

Charging Port

The charging port is located behind the charging port door located rear left of the vehicle. It is incorporated into the master locking system.

To open the door, ensure the vehicle is unlocked, press the charging port door and release - the door will open to reveal the waterproof plug cover.

Remove the plug cover to reveal the combined charging port.

STARTING & DRIVING

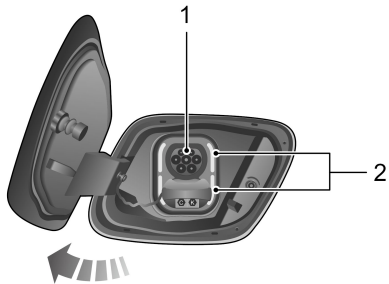

- 1 Slow and Fast Charge Port - 7 Pin - Type 2 Plug
- 2 Rapid Charge Port - 7 Pin and 2 Pin - CCS Type Plug

Note: *In order to use the rapid charger socket, the lower waterproof plug cover will require removal.*

After charging, refit the waterproof plug cover (where necessary), close the charging port door, push the door fully home until the latch locates.

ALWAYS ensure that any excess water is removed from the port area before connecting any charging device.

Charging Port Electronic Lock

In order to prevent the charging connector and cable being disconnected inadvertently during charging, the charging socket features an electronic locking mechanism.

The electronic lock is activated as soon as the vehicle begins charging, and remains in a locked state until the charging is finished or interrupted.

Whilst the charging cable is connected DO NOT attempt to remove the plug.

Manually Releasing the Charging Port Lock in Emergency Situations

The vehicle features an emergency release device for the charging port lock.

To access the manual release, remove the trim plate covering the service access hole on left side of boot -see picture.

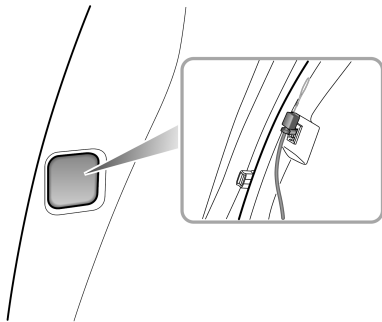

Pull the release cable handle, remove the connector plug whilst maintaining tension on the cable this will release the locking device.

Electric Charging Identifier Label * Identifier Label on Slow Charging Kit

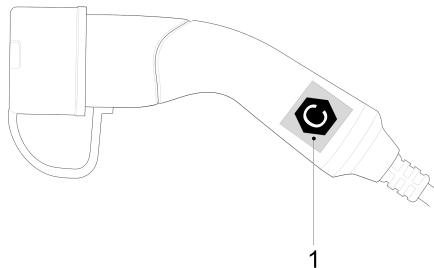

1 AC charging identifier label

Note: Users can purchase a slow charging kit from an MG Authorised Repairer.

STARTING & DRIVING

Identifier Labels on Charging Port

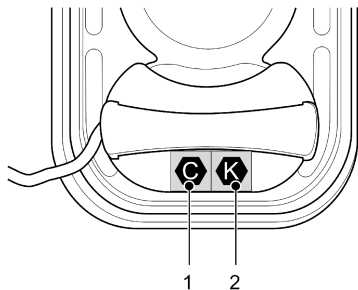



- 1 AC charging identifier label
- 2 DC charging identifier label

Precautions for AC or DC charging

After opening the charging port door, check the charging identifier symbol on the plug cover. Check the charging connector identifier symbol on the AC or DC charger cable. After checking that the alphabetic characters of the charging identifier symbols match, proceed the next charging step.

Note: Risk of failure, fire or injury etc. when using a charging connector with unmatched identifier symbols.

Electric charging identifier label symbol table

Supply Type	Configuration	Type of Accessory	Voltage range	Identifier
AC	7P	Vehicle connector and vehicle inlet	≤480V	
DC	7P+2P	Vehicle connector and vehicle inlet	50V–500V	

STARTING & DRIVING

Rapid Charging

Note: Please read any equipment operating instructions carefully prior to using the rapid charging station. Each type of charger may use different instructions.

Note: The cable of the charging plug should be shorter than 30 m.

If you have any doubts, please seek professional assistance.

Rapid Charging Safety Precautions

Before connecting the rapid charger, switch the vehicle power system OFF and wait 10 seconds.

Note: If at any time during the charging process you should want to check the state of charge, please power on the vehicle. The high voltage battery state of charge will be displayed in the message centre in the instrument pack.

Note: Considering the safety and service life of the high voltage battery, when using a rapid charging station to charge the vehicle the battery will not become fully charged, and therefore the instrument pack may display less than 100% power. If you have a long journey planned, it is recommended that you use a slow charging point to charge the vehicle so as not to affect your journey.

Slow Charging

Note: Carrying out a full slow charge is the only way for the high voltage battery to reach the optimal equilibrium state (equalisation charge).

High voltage battery chargers are available with various power outputs. Chargers with outputs of up to 11kW are generally considered as slow chargers, larger than 11kW are considered as fast chargers and rapid chargers are available in AC or DC outputs. Generally the AC chargers are rated at 43kW and the DC chargers at 50kW plus.

Charging times are dependent on charger output.

To carry out an equalisation slow charge, it is recommended that the charger output does not exceed 11kW.

Note: Chargers of up to 7kW power output are supplied via standard household single phase power. Any chargers that are rated above this, 11kW for example, will require a 3 phase power supply.

AC Charging Points

IMPORTANT

Please ensure that only charge points that meet IEC 61851 and IEC 62196 are used to connect to your vehicle.

Using an AC charging device:

- 1 Ensure the vehicle is power OFF and all doors are closed.
- 2 Open the charging port door.
- 3 Plug the cable from the charger point into the vehicle. Lock the vehicle.
- 4 On completion of the charge, shut off the power, unlock the vehicle and disconnect the plug from the vehicle.
- 5 Ensure the charge socket is free from debris. Close the charging point door.

STARTING & DRIVING

Note: *If at any time during the charging process you should want to check the state of charge, please power on the vehicle. The high voltage battery state of charge will be displayed in the message centre in the instrument pack.*

Residential Charging

During the charging operation the vehicle power system must be OFF. Carry out the following procedure to charge the vehicle:

- 1 Ensure the vehicle is power OFF and all doors are closed.
- 2 Open the charging port door.
- 3 Connect the 7 pin charging plug to the socket on the vehicle.
- 4 Connect the charging device plug to the domestic electricity supply. Lock the vehicle.
- 5 On completion of the charge, shut off the power, unlock the vehicle, disconnect the plug from the vehicle, and then the domestic plug.

- 6 Ensure the charge socket is free from debris. Close the charging point door.

Note: *If at any time during the charging process you should want to check the state of charge, please power off the vehicle. The high voltage battery state of charge will be displayed in the message centre in the instrument pack.*

Charging Information

At the beginning of the charging process, the following information will be displayed within the instrument pack message centre.

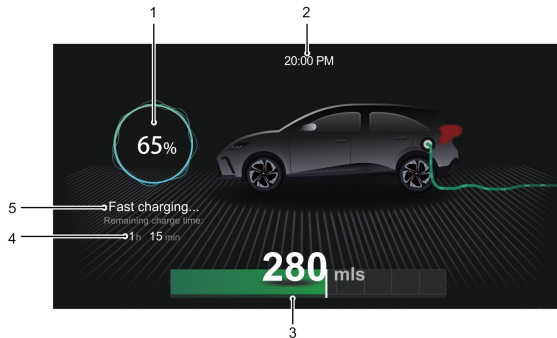

- 1 High voltage battery pack status
- 2 Current time
- 3 Driving range
- 4 Remaining charging time
- 5 Charging status

Note: The information displayed on the instrument pack may be different based on vehicle configuration.

STARTING & DRIVING

Equalisation Charging

Equalisation charging means that after a normal charging process the battery management system will enter a mode where it will attempt to equalise the charge of every battery cell.

If an equalisation charge has not been carried out for sometime, the message centre in the instrument pack will display 'Please Slow-charge the Vehicle'. Please refer to 'Slow Charging' in the 'Starting and Driving' section.

On average it takes at least 10 hours (single phase power) or 7.5 hours (three phase power) to complete a charge that includes the equalisation charge for battery pack type 1.

On average it takes at least 8 hours (single phase power) to complete a charge that includes the equalisation charge for battery pack type 2.

Ambient temperatures have an effect on charging times. It may take longer to complete a charge when the ambient temperatures are low.

Charging Times

Charging times of the high voltage battery can vary depending upon numerous factors, these include: current capacity, charging mode, ambient temperature and device type/power.

Rapid Charging Time

Rapid chargers will vary in power output, on average it will take approximately 40 - 60 minutes to charge the high voltage battery up to 80% (80% displayed in IPK) using an average rapid charger.

Note: Ambient temperatures have an effect on charging times. It may take longer to complete a charge when the ambient temperatures are low or high.

Slow Charging Time

On average it takes approximately 9 hours (single phase power) or 6.5 hours (three phase power) to charge the high voltage battery from low battery warning to 100% for battery pack type 1 (charge quantity can be checked using the instrument pack).

On average it takes approximately 7 hours (single phase power) to charge the high voltage battery from low battery warning to 100% for battery pack type 2 (charge quantity can be checked using the instrument pack).

- At low temperatures the charging time will be extended.
- If an equalisation charge has not been conducted for along time the required charge time will be extended.
- An equalisation charge must be carried out prior to using the car after a long period of storage or non use. In these cases the charging time will be extended.

Note: *The slow charging notes above relate to using an AC charging device. Use of the slow charging device using a domestic power supply can increase the charging times by up to 3 times.*

STARTING & DRIVING

Indicative Charging Times for Battery Pack Type I

Rapid charging		From alarm status to 80%, it takes almost 45 minutes.		
Slow charging	Residential electricity	From alarm status to 100%, it takes almost 20 hours.	From alarm status to 100% and equalisation, it takes almost 21 hours.	For first use after parked or stored status to 100% and equalisation, it takes approximately 22 hours.
	AC charging station (single phase power, approx 7kW)	From alarm status to 100%, it takes almost 9 hours.	From alarm status to 100% and equalisation, it takes almost 10 hours.	For first use after parked or stored status to 100% and equalisation, it takes approximately 11 hours.
	AC charging station (three phase power, approx 11kW)	From alarm status to 100%, it takes almost 6.5 hours.	From alarm status to 100% and equalisation, it takes almost 7.5 hours.	For first use after parked or stored status to 100% and equalisation, it takes approximately 8.5 hours.

Note: *These times are only a guide.*

Indicative Charging Times for Battery Pack Type 2

Rapid charging		From alarm status to 80%, it takes almost 43 minutes.		
Slow charging	Residential electricity	From alarm status to 100%, it takes almost 15.5 hours.	From alarm status to 100% and equalisation, it takes almost 16.5 hours.	For first use after parked or stored status to 100% and equalisation, it takes approximately 17.5 hours.
	AC charging station (single phase power, approx 7kW)	From alarm status to 100%, it takes almost 7 hours.	From alarm status to 100% and equalisation, it takes almost 8 hours.	For first use after parked or stored status to 100% and equalisation, it takes approximately 9 hours.

Note: These times are only a guide.

Note: Alarm status refers to the high voltage battery low warning displayed in the instrument pack message centre. 100% refers to fully charged that the high voltage battery state of charge displayed in the instrument pack message centre. Parked or stored status refers the vehicle has been parked or stored for a long time.

STARTING & DRIVING

Discharging

The vehicle is equipped with a discharge function, this can convert the high voltage DC power in the high-voltage battery pack into domestic AC power.

This discharge function can be realized by using a discharge kit.

Note: Users have the opportunity to purchase the discharge kit from an MG Authorised Repairer.

To use the discharge function, follow the instructions below:

- 1 Unlock the vehicle and access the AC charging port (the charging port is also the discharging port).
- 2 Insert the discharge gun connector into the discharge port socket. When fully connected the discharge port indicator will illuminate blue.
- 3 Access the energy management interface in the infotainment display screen, ensure the cut-off power of discharge is set. After setting, click the start discharging button, the electronic lock will lock the discharge gun in place and the vehicle will enter the discharge state. At this time, do not attempt to

remove the discharge gun using force, this will damage the locking mechanism.

- 4 The user is able to click the stop discharging button in the infotainment display screen to stop the discharge, or stop the discharge after the power is discharged to the set cut-off value. At this time the electronic lock will automatically be released and the discharge gun can be removed.
- 5 Make sure there is no debris or foreign matter in the charging port, fit the charging port cover and close the charging point door.

Note: After the vehicle starts discharging, if the infotainment display goes off, the vehicle will still maintain the discharging condition.

Note: The current power status and available driving range can be displayed on the instrument cluster.

Note: During the discharge process, the user can still set the discharge power cut-off point.

Note: During discharge, the vehicle cannot be placed in "READY" mode.

Note: Using the discharge function will reduce the driving range of the vehicle.

IMPORTANT

- Before beginning the discharge operation, check the condition of the discharge connector and gun.
- If it is necessary to use the discharge function on wet days, please pay particular attention in protecting the discharge port area and discharge gun from water, rain or snow.
- In cases of abnormal phenomena such as peculiar smells, smoke emission or overheating etc during the discharge process, the electrical circuit **MUST** be disconnected immediately and the discharge operation stopped.

STARTING & DRIVING

Pedestrian Alert System

In order to improve the safety, your car is fitted with a Pedestrian Alert System. When the vehicle is travelling at a low speed, the system controls a speaker that sounds to remind pedestrians in the vicinity of your presence.

Strategies of sounding warnings

The speaker sounds when all of the following conditions are met:

- 1 The vehicle is READY;
- 2 The pedestrian alert system is fault free;
- 3 During acceleration, the vehicle speed is less than 18 mph (30 km/h); during deceleration, the vehicle speed is less than or equal to 15 mph (25 km/h).

Electric Drive Transmission

Instructions for Use

The following information is very important, please read carefully before use:

- The electric drive transmission consists of a high voltage unit. **DO NOT** touch any drive components unless you have the correct training and qualifications.
- Depress the brake pedal. When the vehicle power system is **READY**, shift to the required gear.
- Maintain brake pedal application until you are ready to manoeuvre. On a flat road, once the brake pedal is released, the vehicle may automatically start moving slowly without applying the accelerator pedal.

Gear Shift Control

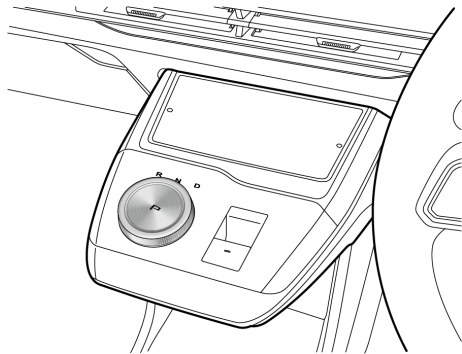

The shift control knob is in the intermediate steady state position, and there are two unsteady positions clockwise and counterclockwise, that is, the shift control knob will return to the intermediate steady state position once released.

Note: When shifting out of the **P/N** gear or into the **R** gear, it needs to depress the brake pedal.

STARTING & DRIVING

- P Park

In this position, the transmission is mechanically locked, and the EPB is applied. Please use this gear when the vehicle is stationary.

Press the P gear button, and the vehicle engages the P gear.

Note: With the brake pedal released, the driver seat belt unfastened and the driver door opened, the vehicle will automatically shift into P gear.

- R Reverse

Select this gear only when the vehicle is stationary and you wish to drive backwards.

Apply the brake pedal, turn the shift control knob counterclockwise to the end and release. The vehicle will enter Reverse.

- N Neutral

Select this gear when the vehicle is stationary (for example, waiting for traffic lights).

When in Park, apply the brake pedal, turn the shift control knob clockwise or counterclockwise to the first non-steady state position and release. The vehicle will enter Neutral.

In Reverse, turn the shift control knob clockwise to the first non-steady state position and release. The vehicle will enter Neutral.

Whilst D is selected, turn the shift control knob counterclockwise to the first non-steady state position and release. The vehicle will enter Neutral.

- D Drive

This is used for normal driving.

In P , R or N , apply the brake pedal, turn the shift control knob clockwise to the end and release. The vehicle will enter Drive.

Driving Mode

The driver can select 5 driving modes through the infotainment display: SNOW , ECO , NORMAL , SPORT and CUSTOM .

Selecting different driving modes will automatically change the power settings of the following systems: Power, Steering, Pedal response, Air conditioning and coasting energy regeneration.

Snow Mode

Snow Mode defaults to Level 1 coasting energy regeneration, which is suitable for driving on slippery roads.

Note: Energy saving mode is disabled when the vehicle is in Snow Mode.

Eco Mode

The vehicle is in the state of low energy consumption, which is used for energy-saving driving.

Normal Mode

The vehicle is balanced for daily driving.

Sport Mode

Sport Mode concentrates on providing more power to enhance the performance.

Constant use of Sport Mode will increase energy consumption.

Note: It is recommended to choose Sport Mode when driving on special road conditions such as mountain roads.

Custom Mode

Custom Mode allows free combination of power, steering and pedal force.

STARTING & DRIVING

Energy Regeneration



Deceleration caused by energy regeneration is NOT a substitute for braking safely. The driver must ALWAYS be prepared to make braking manoeuvres to maintain safe driving.

When the vehicle is in a braking, over-run or coasting state, the energy regeneration function is activated, and the motor converts part of the kinetic energy of the vehicle into electric energy, which is then stored in the high voltage battery pack.

Energy cannot be regenerated or is limited under some conditions, such as:

- N or R gear is selected (During driving do not coast in N gear) ;
- During torque intervention (SCS or traction control operation) ;
- High voltage battery pack is fully charged;
- High voltage battery temperature is too high or too low.

The driver can select 4 different levels of regeneration via the infotainment system.

" Weak " Mode

In "Weak" mode, minimum energy is regenerated, the vehicle exhibits longer coasting distances and no significant sensation of over-run drag or motor braking. The instrument cluster displays ① .

" Medium " Mode

In "Medium" mode, moderate energy is regenerated. The instrument cluster displays ② .

" Strong " Mode

In "Strong" mode, more energy is regenerated, the vehicle exhibits shorter coasting distances and a strong sensation of over-run drag or motor braking. The instrument cluster displays ③ .

" Adaptive " Mode

In "Adaptive" mode, the vehicle will automatically adjust the regeneration intensity based on the road conditions and the distance to the vehicle ahead. The instrument cluster displays ④ .

Energy Saving Mode

When the high voltage battery is low on power, a message will appear on the infotainment display, prompting the driver to enable the energy saving mode. When the energy saving mode is enabled, the vehicle will operate on the minimal energy consumption. The power of the air conditioner is limited. The energy regeneration level is automatically adjusted and fixed to "strong". When the energy saving mode is turned off, the energy regeneration returns to the former-selected level. The energy saving mode can be turned on and off on the infotainment display.

Energy saving mode cannot be enabled when the vehicle is in Snow Mode.

Protection Mode



When parking the vehicle, please ensure the vehicle is parked safely and that all traffic by-laws are observed.

Motor Overheating Protection of the Electric Drive Transmission System

The electric drive transmission may become very hot in a high-temperature environment with frequent starting, frequent rapid acceleration and deceleration, long-term continuous steep climbing, and overload of the electric drive transmission. In order to prevent damage to the motor, the system will perform an overheating protection function, the warning message "EDU Coolant Overheating" displays. In this case, park your vehicle safely or, while keeping a lowload, continue to drive your vehicle at a constant speed to cool the motor. Only when the motor temperature has decreased, and the warning message disappears, can the vehicle be driven normally.

If the electric drive transmission has cooled down for a long time (about 20 minutes) and the warning message has not disappeared, please park the vehicle safely and seek an



STARTING & DRIVING

MG Authorised Repairer immediately. Otherwise it may seriously damage the electric drive transmission.

IMPORTANT

When the motor of the electric drive transmission is under overheating protection, in order to avoid damage to the motor, the power of the vehicle will be limited (the message centre will display "Power Limited, Limiting Speed", and warning indicator  will illuminate). After decelerating, the warnings will disappear when the motor temperature returns to normal.

Electric Drive Transmission Failure

If a general failure is detected in the electric drive transmission system, the warning indicator  on the instrument interface will illuminate in yellow, please drive with caution. For severe functional malfunction, the warning indicator  will illuminate in red. Please park the vehicle safely and contact an MG Authorised Repairer for service as soon as possible.

Gear Shift System Failure

In some cases, when a fault or severe failure is detected in the gear shift system, the message centre will display "EP". For safety reasons, if the vehicle speed is below a preset speed, the power system will isolate the power transmission, and the vehicle will not be able to be driven, please seek an MG Authorised Repairer immediately.

Brake System

Overview

This series of models is equipped with an Integrated Braking System (IBS), which brakes the vehicle through dual circuits. Pay attention to the followings during use of the IBS :

- The IBS only functions with the power system in READY mode. NEVER allow the vehicle to freewheel with the power system turned off.
- If the power system is turned off while driving, you should firmly press the brake pedal, and stop the vehicle as quickly as traffic safely permits.
- If the IBS performance degrades due to a low battery or other reasons, you need to apply more force than usual to the brake pedal to brake effectively.
- If the braking efficiency decreases due to vehicle failure, please contact an MG Authorised Repairer for service as soon as possible.

IBS can provide 3 different braking response modes for the vehicle:

- Comfort: The braking response is slow and the pedal feel is soft.
- Normal: The braking response is moderate and the pedal feel is moderate.
- Sport: The braking response is quick and the pedal feel is sensitive.

You can switch the braking response mode by adjusting the driving mode of the vehicle, or customize the settings on the Infotainment display. If the brake pedal is pressed or the Stability Control System (SCS), Traction Control System (TCS) or Anti-lock Brake System (ABS) is triggered, the switching of braking response modes cannot be completed immediately.

IBS supports brake energy regeneration. When the brake pedal is pressed for braking, the IBS will determine the driver's demand for braking force. The drive motor will convert the vehicle's kinetic energy into electrical energy, which is stored in the high voltage battery when the vehicle is decelerating. This process can improve the range of the vehicle.

The brake system can be divided into service brake system and parking brake system. The service brake system

STARTING & DRIVING

consists of Electronic Brake Force Distribution System (EBD) and Electronic Brake Assistance System (EBA). EBD system can automatically distribute the braking force between the front and rear wheels, so that the vehicle can have good braking performance under different load conditions. The EBA system can increase the braking force applied on each wheel during emergency braking to assist the driver in quickly triggering ABS , thereby shortening the braking distance.

Driving through water or heavy rain may adversely affect braking efficiency. In this case, keep a safe distance from other vehicles and intermittently apply the brake pedal to keep the brake disc surface dry.

Parking Brake System - Electronic Parking Brake (EPB)



When the EPB system cannot be turned off due to malfunction, do not move the vehicle with the rear wheels on the ground, otherwise damages may be caused.

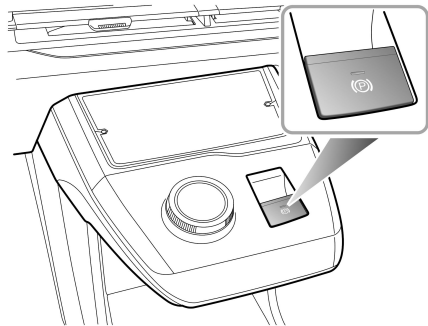

The EPB system can be turned on and off through the following 2 ways:

- Manual operation: Pull up the EPB switch to turn on the EPB system after the vehicle is parked safely. When the vehicle is powered on, press the brake pedal and press the EPB switch to turn off the EPB system.
- Automatic operation: Shift into P gear to turn on the EPB system after the vehicle is parked safely. Park the vehicle safely on a flat road or a road with a small slope, start the power system, and shift into N , D or R gear from P gear to turn off the EPB system.

If the indicator in the EPB switch and the indicator in the instrument pack (P) illuminate, it indicates that the EPB system has been turned on. If the indicator in the EPB switch and the indicator in the instrument pack (P) goes off, it indicates that the EPB system has been turned off.

Note: Always turn on the EPB system every time you leave the vehicle.

Note: An audible motor noise may be heard when turning on or off the EPB system.

Note: On a steep slope, shifting from P gear to other gears will not turn off the EPB system. In this case, please turn off the EPB system manually, or use the Start Assist function of EPB .

IMPORTANT

- DO NOT leave the vehicle before the indicator lamp in the EPB switch illuminates and the gear indicator displays P , the vehicle may not be safely parked due to EPB failure and slip.
- In the event of a flat battery or power failure, it is not possible to apply or release the EPB. In such a case, 'booster cables' shall be used for emergency vehicle start. Please refer to 'Emergency Starting' in 'Emergency Information' chapter.

STARTING & DRIVING

Start Assist

If the driver's seat belt is fastened, and the accelerator pedal is pressed for start off, the EPB system will be automatically turned off.

Emergency Braking Function



Inappropriate use of EPB can lead to accidents and injuries. DO NOT apply the EPB for vehicle braking during vehicle running, unless in an emergency.



During emergency braking using the EPB, DO NOT switch off the power system, this could result in serious injury.

In the event of normal brake failure during driving, emergency braking using the EPB can be initiated by pulling and holding the EPB switch upward. An audible warning will sound during emergency braking. The braking process will be canceled by releasing the EPB switch.

Service Brake System

Anti-lock Brake System (ABS)



The effect of ABS to accelerate the vehicle stop may be limited when driving at high speed or on slippery roads (such as roads with a layer of water that prevents effective contact between the tyres and the road surface). In all cases, it remains the driver's responsibility to maintain safe distance with other vehicles.



DO NOT depress the brake pedal repeatedly at any time; this will interrupt the operation of ABS and may increase the braking distance.

The ABS is mainly used to automatically adjust the braking force of each brake when braking to prevent the wheels from being locked, thus avoiding dangerous situations such as loss of direction or side slip during emergency braking.

This system enables the driver to maintain control over the steering in case of emergency braking, keeps the vehicle stable, and improves the safety factor.

Under normal braking conditions, ABS will not be activated. However, if the braking force exceeds the adhesion between the tyres and the road surface, causing the wheels to lock, the ABS will automatically come into operation.

If emergency braking is required, the driver should apply full braking effort to trigger the ABS even when the road surface is slippery.

Note: On loose gravel, loose soil or snowy roads, the braking distance of vehicles equipped with ABS system may be greater than that of vehicles not equipped with ABS system. This is because wedges may form in front of locked wheels on soft surfaces, thus accelerating the vehicle stop.

IMPORTANT

Although ABS can greatly improve the driving safety, the true safety still depends on the standard driving behavior of the driver.

Stability Control System (SCS) and Traction Control System (TCS)

SCS is designed to assist the driver in control of driving direction. When SCS detects that the vehicle is not moving in the intended direction, it will intervene by applying brake force to selected wheels or through the power system management system to prevent sliding and assist in bringing the vehicle back to the right direction.

TCS contributes to maintain the control to the vehicle by improving the vehicle's traction trafficability and driving stability. TCS monitors the driving speed of each wheel individually. If spin is detected on one wheel, the system automatically brakes that wheel, transferring torque to the opposite, non-spinning wheel. If both wheels are spinning, the power system output torque will be reduced until traction is regained.

SCS and TCS are automatically switched on when the vehicle is powered on. And they can be switched off by using the switch located within the Infotainment display.

STARTING & DRIVING

Note: *Disabling SCS and TCS will not affect the operation of ABS. Always disable SCS and TCS when driving with snow chains fitted.*

Auto Hold



The auto hold function cannot guarantee the stability of the vehicle when starting off or braking on hills especially on slippery or icy surfaces.



When auto hold stops the vehicle for reasons such as power system shutdown, releasing the seat belt or pressing the auto hold switch, the electronic parking brake is applied. It cannot be guaranteed that the vehicle will be stabilised in all cases. For example, the rear wheels are on a snowy or slippery road surface, or the vehicle incline is too great. Please make sure that the vehicle is safely stabilised prior to exiting.



The driver should pay full attention and observe the surroundings even if the vehicle is equipped with auto hold system.



Auto hold cannot guarantee the electronic parking brake operation in all cases where the power system is turned off. Please ensure the electronic parking brake is applied and the vehicle is stabilised prior to exiting the vehicle.



The auto hold function should be switched off during the use of a car washer for automatic car washing, otherwise the electronic parking brake may suddenly apply and cause vehicle damage.

If the vehicle is required to stop frequently for long periods while driving (such as wait at the traffic lights, stop on a slope or stop and go with traffic), the Auto Hold function can assist you in stabilising the vehicle, enabling you to remove your foot from the brake pedal when the vehicle is stationary and the Auto Hold active.

Auto Hold has 3 states as follows:

1 Standby:

With the driver's seat belt fastened, the driver's door closed and the power system in READY mode, touch

the Auto Hold switch on the Infotainment display to switch the Auto Hold function from Off to Standby state.

2 Parking:

When the vehicle is moving forward, press the brake pedal to stop the vehicle, then firmly press the brake pedal to switch the Auto Hold function from Standby to Parking state.

Note: If the vehicle is stopped by firmly pressing the brake pedal, the Auto Hold function will directly enter the parking state.

The Auto Hold will exit the parking state if the brake pedal is firmly pressed again.

The Auto Hold will exit the parking state if gear D is selected and the accelerator pedal is pressed.

The Auto Hold will exit the parking state if gear R is selected.

3 OFF:

Touch the Auto Hold switch located on the Infotainment display to turn off the function.

STARTING & DRIVING

The Auto Hold will exit the parking state under some circumstances such as releasing the seat belt, turning off the power system, remaining static for a length of time or operating the Auto Hold switch. At this time, the EPB will be applied.

Note: *The EPB will NOT be applied when operating the switch to turn the Auto Hold off with the brake pedal pressed.*

Note: *When the vehicle is in R gear, the Auto Hold function will not be triggered.*

Hill Hold Control (HHC)



HHC has limitations when subject to adverse conditions such as wet or icy surfaces, and the driver must always pay attention to the vehicle conditions.



DO NOT exit the vehicle with only HHC applied, it may lead to a serious accident when HHC releases.



During hill start under a stop-and-go road condition, please step on the brake pedal deeply for several seconds before each start.

HHC assists the driver by 'holding' the vehicle during hill starts. If the driver releases the brake pedal, the HHC will hold the vehicle stationary for a short time.

The following conditions must be fulfilled to activate HHC:

- The driver's door is closed and the driver seat belt is fastened.
- The vehicle is stopped steadily on a slope.
- SCS is fault free.

- EPB is fault free and released.
- Power system is in READY mode.
- D or R gear is selected.
- Sufficient brake pedal application force has been applied before start.

Note: *The HHC can also work when the vehicle is reversing uphill.*

Active Rollover Protection (ARP)

The ARP system is a driver aid to assist the stability of the vehicle under extreme conditions. It is not a guarantee that the vehicle will not roll over.

When the vehicle is at risk of rollover during dynamic driving (such as lane change) or steady driving (such as loop driving), the ARP will automatically brake the outside wheels to cause the vehicle to understeer and prevent rollover.

Note: *With ARP in use, the vehicle under-steers and it is normal if it fails to steer fully according to the intent of the driver.*

Emergency Braking Hazard Warning Lights Control System (HAZ)

If the driver makes an emergency braking manoeuvre and certain conditions are met while driving, the brake lamp will automatically flash to alert the drivers behind.

Note: *With the hazard warning lamp turned on, the emergency brake strobe function will not operate.*

STARTING & DRIVING

When the emergency braking manoeuvre is exited, the HAZ function will be switched off after a few seconds.

Note: As the vehicle speed drops to below 6 mph (10 km/h) and the brake lamps no longer flash, the hazard warning lamps will illuminate automatically. Short press the hazard warning lamp button or increase your speed to above 12 mph (20 km/h) for more than 5 seconds to switch off the hazard warning lamps.

Multi-Collision Brake System (MCB)

The MCB function will automatically apply the brake to reduce the vehicle speed and improve the vehicle stability after a collision. It is designed to reduce the risk of a secondary collision caused by the uncontrolled movement of the vehicle after a collision.

The MCB will be activated when the following conditions are all met at the same time:

- A vehicle collision where seat belts or airbags are deployed;
- The vehicle speed is less than 37.5 mph (60 km/h);
- The steering wheel has not been turned in excess of 180 °;

- SCS is fault free.

If the driver firmly presses the accelerator pedal after a collision, the system will not be triggered.

If the driver firmly presses the accelerator pedal after the MCB function is triggered, the system will exit the braking state.

Note: The MCB function cannot guarantee that the vehicle will slow down in all collision situations, as the collision may cause some parts to malfunction or fail, affecting the normal operation of the function.

Adaptive Cruise Control System



The adaptive cruise control system is designed as a comfort system enabling the driver to maintain a constant speed or distance from the car in front. It provides assistance to the driver, it DOES NOT replace any of the drivers responsibilities. When using the adaptive cruise control system, it is important that the driver maintains concentration at ALL times and is prepared to take action. Otherwise, accidents or personal injuries may occur.

The adaptive cruise control system can automatically switch between constant speed cruise and car following cruise depending on whether it can detect a vehicle directly ahead. Constant speed cruise controls the vehicle within a certain speed range. Car following cruise operates by setting the distance between the vehicle and the vehicles directly ahead.

When activated if the adaptive cruise control system detects a vehicle in the same lane directly ahead it may

accelerate or gently apply the brakes of the car to maintain the set following distance.

Note: *The adaptive cruise control system is designed for highways and roads in good condition. It is recommended not to be used on urban roads and mountain roads.*

Activation of Adaptive Cruise Control



After following the vehicle ahead to a stop, the driver must observe any local traffic laws and ensure that there are no obstacles or other traffic participants, such as pedestrians, directly in front of the vehicle before allowing it to pull away and begin to follow the vehicle ahead again.



Whilst using the car following cruise function it is strongly recommended that the driver does not touch the accelerator pedal. Any activation of the accelerator will not allow the system to automatically apply the brakes should this be necessary.

STARTING & DRIVING



DO NOT exit the vehicle when the adaptive cruise control system car following cruise function has stopped the car, or is keeping the car stationary. Before exiting the car the shift control knob should be in the Park position and the power system is OFF.



If the adaptive cruise control system has already stopped the vehicle, and the adaptive cruise control function is disabled, turned off or cancelled, the vehicle will no longer stay still, it may move forward or slip backward. When the vehicle is stopped and kept still by the adaptive cruise control system, be sure to be ready to apply the brakes manually.



When driving on a bend, the adaptive cruise control may actively reduce the vehicle speed to maintain vehicle stability and safety.

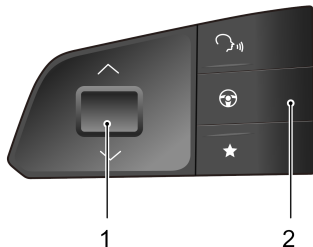

- 1 Adjustment Switch
- 2 Pilot Switch

The adaptive cruise control system can be set with the switch on the infotainment display and the switch on the left of the steering wheel.

- 1 If the switch on the infotainment display is OFF, the adaptive cruise control system is OFF.

- When the switch on the infotainment display is ON, and the pilot switch (2) is pressed briefly, the adaptive cruise control system indicator on the instrument will turn green, and the adaptive cruise control system will be activated (the vehicle speed should be greater than 3 mph for the first activation). Its target speed is the actual speed at activation (if the vehicle speed is below 20 mph, the target speed of the system is set at 20 mph). If the speed of the vehicle ahead is greater than the cruise target speed of your vehicle, your vehicle will maintain the target speed to conduct constant speed cruise. If the speed of the vehicle ahead is lower than the cruise target speed of your vehicle, it will enter the car-following cruise. An image of your car and the car ahead is displayed in the instrument pack message centre. In this mode the actual speed may be less than the set target speed. Whilst in the car following cruise mode, you can follow the vehicle ahead to a stop. If the parking time is less than a preset time period, your vehicle may automatically pull away to follow the vehicle ahead, or you need re-activate the adaptive cruise control system using the method displayed.

Note: *Manual deactivation of either the Traction Control System (TCS) or Stability Control System (SCS) will inhibit the operation of the adaptive cruise control system.*

Adaptive Cruise Target Following Distance Adjustment

When the adaptive cruise control system is activated, press the adjustment switch to the right (increase spacing) or to the left (decrease spacing) to adjust the following distance, which is switched between 3 distance settings and displayed on the instrument.

Select the corresponding following distance according to the relative speed to the preceding vehicle, the higher the relative vehicle speed, the longer the distance is. Considering the traffic and weather conditions, the range of optional following distance may not be suitable for all drivers and driving conditions.

Adaptive Cruise Target Speed Adjustment

When the adaptive cruise control system is activated:

STARTING & DRIVING

- Use the accelerator pedal to reach the desired speed, press the adjustment switch (I), and then release the adjustment switch and accelerator pedal, so that the vehicle will cruise at the desired speed.
- When the adjustment switch is moved upward and held, the target speed will increase until the required set speed appears on the instrument, and then release the switch. When it is determined that there is no vehicle ahead or the vehicle ahead exceeds the preselected following distance, the vehicle speed will increase to the set speed.
- When the adjustment switch is moved downward and held, the target speed will decrease until the required set speed appears on the instrument, and then release the switch, the vehicle speed will decrease to the set speed.
- When the target speed is adjusted by using the adjustment switch, it will change by 5 mph each time the switch is moved briefly; When the switch is moved and held, the target speed will continue to rise or fall at 1 mph until the switch is released.

Note: *If the vehicle ahead continuously makes hard acceleration or deceleration, the ACC system may not be able to keep the following distance accurately, the driver must pay attention and perform the operations such as braking or lane change in time according to the surrounding environment.*

Adaptive Cruise Pause/Standby

When the adaptive cruise control system is active, short press the pilot switch to cancel the function, and the adaptive cruise control system will exit to the Standby state.

Automatic Deactivation of Adaptive Cruise

In the following situations, the adaptive cruise control system may be automatically deactivated, this transfers full control of the vehicle to the driver.

- Turn off the adaptive cruise control system switch on the infotainment display.
- Press the brake pedal whilst the vehicle is in motion.
- Move the rotary gear knob to either R or N position.
- The driver unfastens his/her seat belt.

- Press and hold the accelerator pedal beyond a preset time period.
- Open any door, bonnet or tailgate.
- Pull the EPB switch up to apply the parking brake.
- Follow the vehicle ahead to a stop and the stop time exceeds a certain period of time.
- The camera or radar view is blocked, the surrounding environment triggers the preset safe exit mechanism of the sensors, or the system fails.

Note: *If following the vehicle ahead to a stop with the adaptive cruise control system enabled, if any of the following conditions occur whilst the vehicle is in a stopped state, the EPB will automatically be applied:*

- **The driver unfastens the seat belt;**
- **The driver door is opened;**
- **The stationary time exceeds the preset time period.**

Adaptive Cruise Override

If the driver has cause to use the accelerator pedal when the adaptive cruise control system is activated, the vehicle will remain in Cruise mode while the vehicle speed increases. When the accelerator pedal is released, the

adaptive cruise control system will resume to operate at previously set cruise speed.

Adaptive Cruise Resume

After the adaptive cruise control system is paused and not turned off, it can be reactivated by moving the switch upward. The target cruise speed will automatically be set to the target speed before exiting the adaptive cruise control system.

Clearing Target Speed Memory

The adaptive cruise control system can be turned off by turning off the adaptive cruise control system switch on the infotainment display, and the speed set by the adaptive cruise control system in the memory will be cleared synchronously. The stored set speed will also be cleared by turning off the Start switch.

Adaptive Cruise Control System Impairment and Ineffectiveness

- Encounters a vehicle or object which is stationary or traversing the lanes.

STARTING & DRIVING

- Approaching the vehicle ahead too fast, and the system cannot apply sufficient braking force.
- The vehicle ahead is an oncoming vehicle, or makes an emergency braking manoeuvre.
- Vehicle ahead is reversing.
- A vehicle suddenly cuts into the lane in front.
- Encounters a vehicle driving at a low speed.
- Encounters a vehicle with loaded items protruding from the body profile of the vehicle.
- Encounters a vehicle with a higher chassis (e.g. a truck).
- Encounters pedestrians, non-motor vehicles or animals.
- The vehicle is driving on an uneven road or a complex traffic road section.
- The vehicle makes a sharp turn.
- Enters and leaves a tunnel or drives in the tunnel.
- Drives in the shade of mottled trees.
- Excessive weight being carried in the load space or cargo area causing the front of the car to point upwards.

Special Driving Environments

The adaptive cruise control system has its limitations. Listed below are some conditions that may be beyond the safe operating limits. The driver should maintain control of the vehicle and must remain alert at all times. They should pay special attention to the traffic conditions and surroundings, select the appropriate speed and be ready to take any required actions.

- I When turning at an intersection or following a vehicle into, or out of a curve, the adaptive cruise control system may be unable to detect the vehicle ahead, even if it is in the same lane, it is possible the system may detect a vehicle in another lane.

Note: Do not use the adaptive cruise control system on entrance/exit ramps or sharp bends.

STARTING & DRIVING

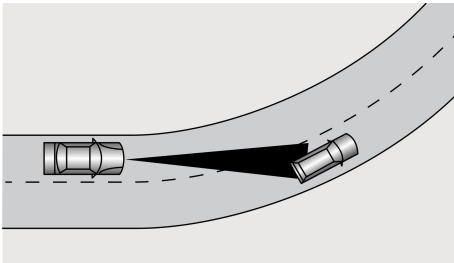
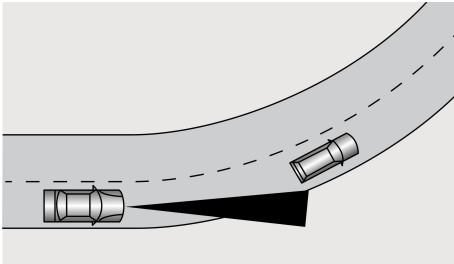

- 2 If the vehicle ahead changes lanes, but does not drive into the lane completely, the adaptive cruise control system may be unable to detect the vehicle.

If the vehicle ahead changes lanes, but does not exit the lane completely, the adaptive cruise control system may determine that the vehicle ahead has exited the lane and accelerate to any preset speed.

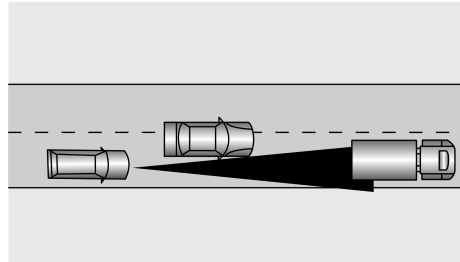

- 3 When driving on uneven roads that may include steep climbs or dips please **DO NOT** use the adaptive cruise control system.

STARTING & DRIVING

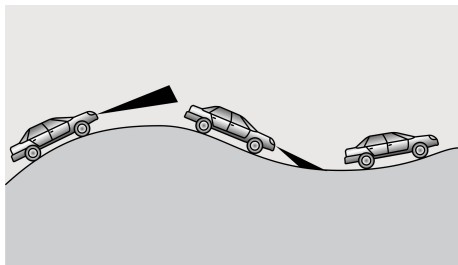

- 4 When driving behind a vehicle that is only partially overlapping your vehicle, ' A ' in the graphic, the adaptive cruise control system may be unable to detect anything.

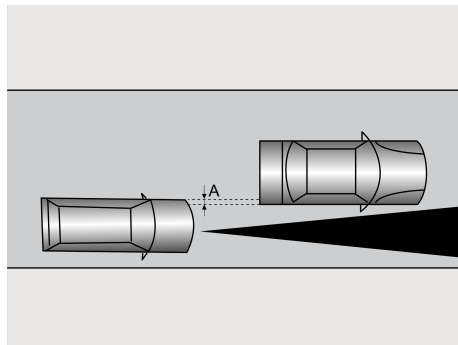

Note: Please DO NOT use the adaptive cruise control system in the following situations:

- **Driving in bad weather conditions.**
- **When the ambient light is insufficient, the light is too bright, or the forward lighting of the vehicle is poor.**
- **Driving on rough or poor road surfaces.**
- **Driving through roadworks or construction sites.**
- **Driving on low friction roads.**

Driving Assist System

The driving assist system can detect the road and environmental information ahead of the vehicle by utilising a front view camera and a front detection radar under certain conditions. This information is used to relay warning messages or provide assistance to help the driver control the vehicle more safely and reliably. The front view camera is located in the interior rearview mirror base cover, the front detection radar is located at the lower middle of the front bumper.

Note: *DO NOT operate any infotainment switches whilst driving. If you wish to make any settings changes, please pull over when it is safe and legal to do so.*

Description of Front View Camera

Calibration of Front View Camera

The front view camera re-calibration is required after any of the following:

- Removal and refitting of the front view camera.
- Replacement of the windscreen.

Note: *The calibration of front view camera requires professional knowledge and tools. If calibration is required, please seek an MG Authorised Repairer.*

Obstruction of the front view camera

On occasion the front view camera view may become obstructed by foreign objects or stains on the glass. In these cases a prompt message will appear in the information centre. Please wipe or clean immediately.

STARTING & DRIVING

In the following situations, the detection performance of front view camera will be affected:

- Driving in poor weather conditions where visibility is reduced due to thick fog, heavy rain, snow, dust or sand storm etc.
- Affected by light, for example low light levels at night, poor auxiliary lighting, excessive backlighting in the view, light from oncoming vehicles, abrupt change of brightness with a quick bright/dark jump (tunnel entrance/exit), driving on surfaces with strong reflective properties (road surface covered with water or snow), tunnels, inside a building etc.
- The front view camera is partially or fully blocked by obstacles, e.g. dust, foreign objects, oil pollution, mud, snow, excessive water (rain), frost or water spray from the road on the windscreen.
- The windscreen in view is damaged.
- Not calibrated after removing/refitting the front view camera or the windscreen.
- The front view camera is not secured in place.

Description of Front Detection Radar

Calibration of Front Detection Radar

The front detection radar re-calibration is required after any of the following:

- The front detection radar mis-alignment failure, for example the position of the front detection radar has changed.
- Remove/refit the front detection radar or radar bracket.
- Remove/refit the front anti-collision beam.
- The four-wheel alignment parameters have changed.

Note: If the front detection radar is subject to strong vibration or slight impact, the mounting position of the front detection radar needs to be checked and re-calibrated as necessary.

Note: The calibration of front detection radar requires professional knowledge and tools. If calibration is required, please seek an MG Authorised Repairer.

Front radar performance will be effected in the following situations:

- When the front detection radar is covered by mud, snow, excessive water (rain) or water spray from the road.
- When the radar or surrounding areas are covered by objects such as labels or auxiliary lighting installation.
- When the front detection radar is subject to strong vibration or slight impact.
- Some targets may affect and weaken the detection capability of the front detection radar, such as road barriers, fences and tunnel entrances.
- When the front detection radar is affected by the environment, such as strong electromagnetic field interference or due to the target itself.
- Strong reflected radar signals (such as: in multi-storey car parks, tunnels, sprinkler spray systems or water jets etc). Experiencing any of these could cause the function of the front detection radar to be effected.

Note: Any snow that gathers on the front radar may be removed using a soft brush, and any ice should be removed using a propriety deicing spray.

Note: Avoid any collision or contact with the front radar module, this may cause misalignment.

STARTING & DRIVING

Speed Sign Recognition



The intelligent speed assist system is an auxiliary function. It may display an incorrect speed limit value or no speed limit value in the instrument pack due to various factors. As a result, the vehicle speed is not restricted within the correct range. The driver still needs to observe the speed limit of the road traffic, and speeding is strictly prohibited.



The front view camera cannot recognise speed limit signs painted on the road surface. The driver MUST observe these speed limits and adjust their speed accordingly.

The setting interface of the speed sign recognition is located on the infotainment display, and the driver can choose to turn on or off the speed sign recognition system through the soft switch on the infotainment display. The vehicle detects the speed limit sign (such as ) at the roadside with the front view camera. When the vehicle

speed exceeds the speed in the speed limit sign speed indicator, the speed limit sign speed indicator will flash, and the driver is reminded to reduce the vehicle speed through the audible alarm and prompt message on the instrument pack.

When the speed sign recognition is enabled, the speed limit sign speed indicator will illuminate. When the vehicle passes the first identified speed limit sign, the speed limit sign speed indicator will display the real-time speed limit value. When encountering a speed limit sign with the same speed limit value, the speed limit value in the speed limit sign speed indicator will not be updated.

Note: After the car identifies a speed limit sign, if no new signs (same or different) are identified beyond a certain mileage, the original speed limit value on the instrument pack will be reset and displayed as "–". The driver MUST observe these speed limits and adjust their speed accordingly.

Note: *When the vehicle needs to change lane, make a turn or turn around at an intersection and the driver uses an indicator in advance and slows down, the original speed limit value on the instrument pack will be reset until a new speed limit sign is detected. If the conditions are not met, the original speed limit value will be maintained and not be reset. The driver MUST observe the speed limits and adjust their speed accordingly.*

Speed sign recognition may not work properly in the following situations:

- 1 The detection performance of the front view camera is affected.
- 2 The vehicle is being driven at high speed.
- 3 The speed limit signs are obscured along the road, for example: by trees, ice/frost, snow, dust, etc.
- 4 The speed limit signs are incorrectly placed or damaged.
- 5 There are multiple speed limit signs above the lane or on the sides of the road. Currently, the front view

camera can only recognise the speed limit signs for the lane in which the vehicle is being driven.

- 6 Non standard speed limit signs or signs that contain additional information.
- 7 The speed limit signs set up at a fork in the road, on a bend or on-ramp/off-ramp.
- 8 During manoeuvres such as lane-changing.
- 9 The vehicle is driven in non-sales area or the units selected on the infotainment display does not match with the current country.

STARTING & DRIVING

IMPORTANT

- In poor lighting conditions or poor weather, or in case the speed limit signs are irregular or being sheltered, the camera may not identify all speed limit signs or make error identification (e.g. identify the weight limit sign as a speed limit sign, identify the minimum speed sign as the maximum speed sign etc.)
- The camera cannot recognize the text messages provided below the speed limit sign, such as Auxiliary Lane, 100 m Ahead, School Section, 7:00-10:00 . The camera will recognize the speed limit sign with text messages as a normal speed limit sign.
- Some drastic and rapid steering operations of the driver may be judged as changing lane or turning around in the intersection by the system, resulting in the identified speed limit signs being cleared.

Speed Limit Assistance System



Speed limit assistance system is only an auxiliary function. Due to that the speed limit sign is not standardized or the front view camera is blocked, the wrong speed limit value or no speed limit value may be displayed on the instrument pack, and the vehicle is not restricted in the correct speed range, so the driver still needs to be responsible for real-time evaluation of the speed limit on the road.



The front view camera cannot recognise speed limit signs painted on the road surface. The driver MUST observe these speed limits and adjust their speed accordingly.

The setting interface of the speed limit assistance system is located on the infotainment display. Enter the vehicle setting interface and find the setting interface of the speed limit assistance system to select the mode: Intelligent, Manual or OFF.

- 1 Intelligent: Intelligent speed limit. The vehicle detects the speed limit sign (such as ) at the roadside with the front view camera, and intervenes the speed control to keep the vehicle speed in the permitted maximum speed limit.
- 2 Manual: Manual speed limit. The driver sets the maximum speed via the buttons on the left of the steering wheel, actively intervenes in the speed control, and keeps the speed within the allowable maximum speed limit, as described in the section "Manual Speed Limit Settings".
- 3 OFF: Turn off the speed limit assistance system.

Note: *If mode selection is disabled, please confirm that the intelligent driving is turned off on the infotainment display and try again.*

Manual Speed Limit Settings

After switching to the manual speed limit, you can set the target speed limit via the buttons on the left of the steering wheel as follows:



- 1 When the manual speed limit is enabled, it enters the standby state, and the speed limit assistance system indicator on the instrument pack illuminates in white. The manual speed limit function can be activated by pressing the Pilot switch (2 as shown below), and the speed limit assistance system indicator illuminates in green. When the Pilot switch is pressed for the first time, if the actual vehicle speed is lower than 20 mph / 30 km/h, the target speed limit value displayed on the speed limit assistance system indicator will be 20 mph / 30 km/h; If the actual vehicle speed is higher than 20 mph / 30 km/h, the target speed limit value will be displayed as the multiple of 5 by rounding up the current vehicle speed to the nearest integer. After that, press the vehicle speed adjustment button (1 as shown below) up and down to adjust the target speed limit value of the manual speed limit. The target speed limit will increase or decrease by 5 mph for each press of the button. Hold the up or down button, and the target speed limit value changes continuously in units of 5 mph.

STARTING & DRIVING

- 2 After the manual speed limit is activated, the system will actively limit the vehicle to not exceed the target speed limit; when the actual vehicle speed exceeds the target speed limit set by the driver, the system will gradually reduce the vehicle speed below the target speed limit.
- 3 After the manual speed limit is activated, the driver can press the Pilot switch (2 as shown below) to allow the system to return to the Standby state. Press the Pilot switch (2 as shown below) again to resume the manual speed limit.

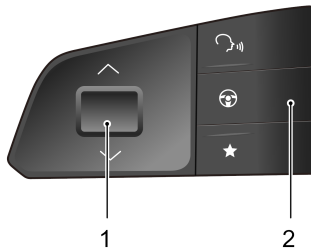

Intelligent Speed Limit Settings



When the intelligent speed limit is enabled, the status indicator of the speed limit assistance system will illuminate in green. When the vehicle passes the first identified speed limit sign, the speed limit sign speed indicator will display the real-time speed limit value. When encountering a speed limit sign with the same speed limit

value, the speed limit value in the speed limit sign speed indicator will not be updated.

Note: *After the car identifies a speed limit sign, if no new signs (same or different) are identified beyond a certain mileage, the original speed limit value on the instrument pack will be reset and displayed as "-". The driver MUST observe these speed limits and adjust the their speed accordingly.*

Note: *When the vehicle needs to change lane, make a turn or turn around at an intersection and the driver uses an indicator in advance and slows down, the original speed limit value on the instrument pack will be reset until a new speed limit sign is detected. If the conditions are not met, the original speed limit value will be maintained and not be reset. The driver MUST observe the speed limits and adjust their speed accordingly.*

The driver can temporarily exit the speed limit assistance system via the following operations:

- 1 Depress the accelerator pedal hard to exceed the speed limit temporarily; at this time the speed limit assistance system indicator on the instrument pack illuminates in green and flashes (at manual speed limit

mode) or the speed limit sign on the instrument pack flashes (at intelligent speed limit mode);

- 2 Briefly pressing the Pilot switch (2 as shown above) can temporarily exit the speed limit assistance system function. In this case, the speed limit assistance system indicator in the instrument pack will change into white. Short press the Pilot switch again to resume the speed limit assistance system function.

STARTING & DRIVING

Intelligent speed limit may not work properly in the following situations:

- 1 The detection performance of the front view camera is affected.
- 2 The vehicle is being driven at high speed.
- 3 The speed limit sign is blocked by trees, frost, snow, dust, etc.
- 4 The speed limit signs are incorrectly placed or damaged.
- 5 There are multiple speed limit signs above or on the side of the road. Currently, the front view camera can only recognize the speed limit sign of the current lane.
- 6 Non standard speed limit signs or signs that contain additional information.
- 7 The speed limit signs set up at a fork in the road, on a bend or on-ramp/off-ramp.
- 8 During manoeuvres such as lane-changing.

- 9 The vehicle is driven in non-sales area or the units selected on the infotainment display does not match with the current country.

IMPORTANT

- In poor lighting conditions or poor weather, or in case the speed limit signs are irregular or being sheltered, the camera may not identify all speed limit signs or make error identification (e.g, identify the weight limit sign as a speed limit sign, identify the minimum speed sign as the maximum speed sign etc.)
- The camera cannot recognize the text messages provided below the speed limit sign, such as Auxiliary Lane, 100 m Ahead, School Section, 7:00-10:00 . The camera will recognize the speed limit sign with text messages as a normal speed limit sign.
- Some drastic and rapid steering operations of the driver may be judged as changing lane or turning around in the intersection by the system, resulting in the identified speed limit signs being cleared.

Lane Assist System



The lane assist system is an auxiliary system that provides assistance to the driver. It does NOT remove the responsibility of safe driving from the driver. When choosing to use the lane assist system, the driver MUST always pay attention to the surroundings, hold the steering wheel and be prepared to make manoeuvres at any time. Failure to maintain overall control of the vehicle may result in an accident or personal injury.



The lane assist system does not always recognise the lane lines. Sometimes poor road surfaces, certain road structures or objects may be mistaken for lane lines. When such situations occur, the lane assist system must be immediately turned off.

The lane assist system switch is located in the infotainment display. Enter the corresponding interface for driving assistance to turn the system ON/OFF, and make mode selection.

Alert

The system uses the front view camera to detect the lane lines ahead of the vehicle. The system will be activated when the following detection conditions are met:

- The function is switched ON.
- Vehicle speed is above 37 mph(60 km/h).
- Lane line markings are clear and the system recognises at least one lane line.

When a wheel is about to cross the lane line, or has already crossed the line, the system will provide warnings to prompt the driver to take action and maintain the vehicle position between the lane lines. The function will automatically exit when the vehicle speed drops below 34 mph(55 km/h).

Lane Departure Assist

The system uses the front view camera to detect the lane lines ahead of the vehicle. The system will be activated when the following detection conditions are met:

- The function is switched ON.
- Vehicle speed is above 37 mph(60 km/h).

STARTING & DRIVING

- Lane line markings are clear and the system recognises at least one lane line.

When a wheel is about to cross the lane line, or has already crossed the line, the system will provide assistance to the driver by keeping the vehicle in between the lane lines by applying corrective steering intervention and simultaneously displaying a prompt. The function will automatically exit when the vehicle speed drops below 34 mph(55 km/h).

Emergency Lane Keeping *

The system detects the following objects:

- Lane lines ahead of the vehicle.
- Kerbs ahead of the vehicle.
- Oncoming vehicles in the adjacent lane.
- Overtaking vehicles in the adjacent lane.

The system will be activated when the following detection conditions are met:

- The function is switched ON.
- Vehicle speed is above 37 mph(60 km/h).
- Lane line markings are clear and the system recognises at least one lane line.

When a wheel is about to cross the lane line or kerb, or has already crossed the line or kerb, or the vehicle in the adjacent lane is nearing the vehicle and the vehicle is leaning to the middle lane line simultaneously, the system will provide assistance to the driver by keeping the vehicle in between the lane lines or kerbs, or avoiding sharply by applying corrective steering intervention and simultaneously displaying a prompt. The function will automatically exit when the vehicle speed drops below 34 mph(55 km/h).

In cases of several interventions within a certain period of time and in the absence of detecting any steering input by the driver during the interventions, the system will provide warnings.

IMPORTANT

- In cases where the number of lanes increase or lanes merge, the driver **MUST** take full control of the vehicle.
- In areas where there are complex traffic conditions such as intersections or road junctions with congestion, the driver **MUST** take full control of the vehicle.

The lane assist system will be impaired or ineffective in the following conditions:

- The driver indicates in the direction of the lane line about to be crossed.
 - The hazard lamps are activated.
 - The driver applies the accelerator rapidly, carries out an emergency manoeuvre or makes a hard brake pedal application.
 - The system detects that the driver has not moved the steering wheel for a preset time period (in the mode of lane departure assist and emergency lane keeping).
- During system intervention the steering wheel is operated (in the mode of lane departure assist and emergency lane keeping).
 - The lane line is too thin, damaged, or fuzzy.
 - Irregular or damaged kerbs.
 - The vehicle is driven on the bend with a small curvature radius, the road is too narrow or too wide.
 - The vehicle has just entered a road section with lane lines or is driven on a road section without lane lines.
 - The vehicle changes lanes or sways laterally too fast.
 - The vehicle is not in D.
 - The vehicle speed is below 34 mph(55 km/h), or too high.
 - The anti-lock brake system (ABS) and the dynamic stability control system (SCS) are activated.
 - Faults exist in the anti-lock brake system (ABS), dynamic stability control system (SCS), electric power steering system (EPS), etc.

It is recommended to turn off the lane assist system in the following situations:

- Driving in a sports style or manner.
- Driving in bad weather conditions.

STARTING & DRIVING

- Driving on rough or poor road surfaces.
- Driving through roadworks or construction sites.

Traffic Jam Assist System



Traffic jam assist system is an auxiliary system that provides assistance to the driver. It does NOT remove the responsibility of safe driving from the driver. When choosing to use the traffic jam assist system, due to the limitations of system detection and control, the driver must always be careful and hold the steering wheel at all times. The driver needs to correct or take over the steering wheel control if necessary. Failure to maintain overall control of the vehicle may result in an accident or personal injury.

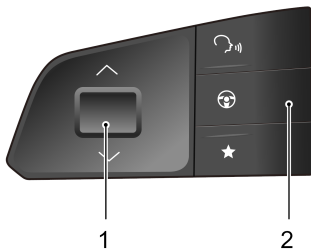

- Adjustment Switch (1)
- Pilot Switch (2)

The system switch is located on the infotainment display, and it can be turned on/off by entering the corresponding interface of driving assistance.

When the following conditions are met:

- The traffic jam assist system switch on the infotainment display is on.

- The system detects lane lines on both sides of the vehicle.
- The vehicle is in Drive gear.

Short press the pilot switch to activate the traffic jam assist system. The traffic jam assist system works on the basis of the adaptive cruise control system. If the lane lines ahead on both sides are clear, the system will assist the vehicle in driving within the lane lines. When driving at a low speed, if there is a vehicle ahead and the lane lines are not clear, the system can assist the vehicle in following the track of the vehicle ahead.

Note: *With the ACC system activated, the traffic jam assist system can be activated without pressing the pilot switch when the above conditions are met.*

In the absence of a steering input from the driver for a certain period of time, the system will provide warnings.

STARTING & DRIVING

Note: *The driver should adjust the vehicle speed and the following distance according to the road visibility, weather and road conditions. The traffic jam assist system does not respond to pedestrians, animals, stationary vehicles and vehicles that drive across the lane or oncoming vehicles in the same lane. If the traffic jam assist system cannot reduce the vehicle speed timely and effectively, the driver **MUST** apply the brakes. In congested conditions, should another vehicle cut into the lane being used by the vehicle under traffic jam assist system control, the system may not detect the vehicle in adequate time to make a braking manoeuvre. In this case the brakes should be applied by the driver.*

The traffic jam assist system will be impaired or ineffective in the following conditions:

- The hazard lamps are activated.
- The driver indicates in the direction of the lane line about to be crossed.
- The driver applies the accelerator rapidly, carries out an emergency manoeuvre or makes a hard brake pedal application.

- The system detects that the driver has not moved the steering wheel for a preset time period.
- During system intervention, the steering wheel is being manipulated by the driver.
- The lane line is too thin, damaged, or fuzzy.
- The vehicle is being driven on a bend with a small curvature radius, the road is too narrow or too wide.
- The vehicle has just entered a road section with lane lines or is being driven on a road section without lane lines.
- The vehicle is not in D.
- The vehicle changes lanes or sways laterally too fast.
- The turning radius of the car using the traffic jam assist system to track in front is too small.
- The anti-lock brake system (ABS) and the dynamic stability control system (SCS) are activated.
- Faults exist in the anti-lock brake system (ABS), dynamic stability control system (SCS), electric power steering system (EPS), etc.

It is recommended to turn off the traffic jam assist system in the following situations:

- Driving in a sports style or manner.

- Driving in bad weather conditions.
- Driving on rough or poor road surfaces.
- Driving through roadworks or construction sites.
- Driving on steep, winding or slippery roads (such as snow covered and icy roads, wet roads and roads covered with water).
- Driving on grass tracks or unpaved roads.

IMPORTANT

- In cases where the number of lanes increase or lanes merge the driver **MUST** take full control of the vehicle.
- In areas where there are complex traffic conditions such as intersections or road junctions with congestion, the driver **MUST** take full control.
- The driver **MUST** be aware of the surroundings and be able to assume full control of the vehicle when using the traffic jam assist system to track the car in front should the need arise.

Forward Collision System



*The driver remains responsible for the safety of the entire driving process, even if the vehicle is equipped with a forward collision system. The driver **MUST** pay full attention and drive carefully. As with all the driver assist systems, the forward collision system cannot prevent accidents or avoid collisions in all situations. The driver **MUST** always remain in control to avoid accidents or emergency situations.*



*Emergency braking whilst under the control of the forward collision system may cause injuries to the passengers. Therefore, drive carefully and all passengers **MUST** wear seat belts at all times.*

STARTING & DRIVING



Ensure the forward collision system or vehicle power system is switched off when being towed. If the forward collision system is enabled when the vehicle is being towed, adverse effects may affect the safety of your vehicle, the towing vehicle and the people around.



To avoid the occurrence of accidents, never specially test the functions of the forward collision system.

The forward collision system switch is located in the infotainment display. Enter the corresponding interface for driving assistance to turn the system ON/OFF, and make mode selection.

Alert

When the system detects that there is a risk of collision between the vehicle and the vehicle in front in the same lane, warnings will be provided to prompt the driver to slow down in time and keep a relatively safe distance from the vehicle ahead.

Emergency braking

When the system detects that there is a risk of collision between the vehicle and the vehicle directly in front of the vehicle, the brake system will automatically intervene to decelerate the vehicle, so as to avoid collision accidents or mitigate damage from collision accidents. If the vehicle is braked and stopped under the system control, it will remain stationary for a short time. Full control of the vehicle will then be returned to the driver.

The system will only slow down the vehicle automatically if the following conditions are met:

met:

- The dynamic stability control system (SCS) and traction control system (TCS) are fault-free and ON.
- The vehicle is in D or N.
- The airbags are not deployed.

Note: *In some cases, the driver may not have anticipated any braking intervention and does not want to apply the brakes whilst the forward collision system is braking heavily, the driver can temporarily cancel this operation by heavily pressing the accelerator pedal after ensuring that it is safe to do so.*

The operation of the forward collision system may be impaired or ineffective in the following situations:

- The vehicle ahead approaches head-on, crosses the intersection or jumps the queue rapidly in a short distance.
- The vehicle ahead does not follow the rules of driving and parking (such as drives on the lane lines).
- The vehicle ahead is not in the same lane as your vehicle or the vehicle ahead is partially obscured.
- The vehicle ahead is an abnormal vehicle (modified or abnormal shape).
- The vehicle ahead is a vehicle with higher chassis.
- The vehicle ahead is a large vehicle at close range (such as tractor, trailer, towing vehicle, mud truck, sanitation truck, sprinkler truck etc.).
- The vehicle ahead is unusual transportation (such as a horse, cart, carriages etc.).
- The system detects the side of a vehicle.
- The contour of the vehicle ahead is unclear (such as water being sprayed by the wheels of the front and surrounding vehicles).
- The vehicle ahead does not have or has obscured tail lamps when driving at night or in a tunnel.
- The tail lamps of the vehicle ahead are all LED strip lights or other homemade coloured lamps.
- The street lights are inconsistent or flickering when driving at night.
- The pedestrian is not directly in front of the vehicle, or the pedestrian is not fully visible.
- The pedestrian is not standing upright, or it is a child under a certain height.
- There is a group of pedestrians in front of the vehicle that is over-shadowed or in the dark.
- There are animals in front of the vehicle.

STARTING & DRIVING

- Objects such as special-shaped ground obstacles (e.g. roadblocks, isolation piles, isolation strips, large stones, other scattered objects etc.) are detected in front of the vehicle.
- Objects such as signs, guardrails, bridges, buildings or other are detected in front of the vehicle.
- The vehicle is being driven on a hillside road, upper and lower bridge section or tight bend.
- The vehicle is in R.
- The vehicle is in a state of braking or rapid acceleration.

Parking Aid

Ultrasonic Sensor Parking Aid



The purpose of the parking aid is only to assist the driver in parking! The ultrasonic sensors may not be able to detect certain types of obstructions, e.g. narrow posts or small objects no more than a few inches wide, small objects close to the ground, objects above the tailgate and some objects with non-reflective surfaces.



Keep the ultrasonic sensors free of dirt, ice and snow. If deposits build up on the surface of an ultrasonic sensor, its performance may be impaired. When washing the car, avoid aiming high pressure water jets directly at the ultrasonic sensors from close range.

Rear Parking Aid

The ultrasonic sensors on the rear bumper monitor the area behind the vehicle to search for obstacles. If an

obstruction is detected, the system calculates its distance from the rear of the car and communicates this information to the driver by an alarm sound.

Note: *When towing mode is active, rear parking aid system and rear driving assistance system will be disabled.*

Operating State of the Parking Aid

Rear Parking Aid

The parking aid is enabled automatically when the R gear is selected, it is switched off as soon as the R gear is disengaged. A short beep is given by the parking aid within 1 second after selecting R gear to indicate that the system is operating normally.

Note: *If a longer, higher pitched sound is emitted for 3 seconds when the R gear is selected, this indicates a fault in the system. In this case seek assistance from your MG Authorised Repairer.*

STARTING & DRIVING

Rear Parking Aid

With the parking aid function enabled, if an obstacle is detected, the audible sounds in different frequencies are transmitted (there might be blind zones).

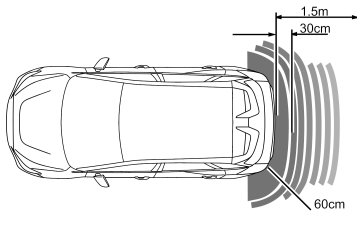

- Once the obstacle is within a 30 cm range of the rear bumper, the alarm sound will merge into a continuous warning.

- If an obstacle is located within 1.5m range of the rear sensors or within 0.6m range of the corner sensors, the warning commences. As the car moves closer to the obstacle, the audible sounds are transmitted more rapidly.

360 Around View System *



The purpose of the 360 around view system is to assist the driver during parking, The cameras have a limited field of view and cannot detect obstructions outside the field of view.



Although the infotainment display can provide images around the vehicle, please still pay attention to the current actual road conditions for your driving safety.



Please ensure that the exterior rearview mirrors are unfolded when using the 360 around view system.

With the 360 around view system activated, the infotainment display will display the 360 degree panoramic image of the vehicle to facilitate the observation of the surrounding environment in order to assist with safer driving. Buttons on the infotainment display can be touched to view the images from different angles around the vehicle.

The 360 around view system can be enabled using the following methods:

- Selecting Reverse gear.
- Operating the 360 button.
- Using the 'Setting' interface to select low speed switching of corner lights/indicators, this will automatically open the 360 around view system when the indicators are used at low speeds and exit when the indicators are cancelled.

In the 360 around view system display interface, select the settings icon to enable personal settings for system functions.

Note: *When the shift lever is placed in a forward gear position, the 360 around view systems is inhibited at speeds above or equal to 10 mph(15 km/h)*

STARTING & DRIVING

Rear Driving Assistance System *

System Overview



The rear driving assistance function is only an aid, it is NOT a substitute for the attention of the driver. The driver must always remain in control, observe the surroundings and drive safely.



The effective recognition capabilities of the rear sensors can be limited by objects such as roadside buildings, guardrails, changes in pitch angle of the car due to heavy loading, road conditions such as bends or bumps or weather conditions such as snow and ice etc. Any of the above may trigger a false alarm.



The rear driving assistance system may not provide adequate warning of very fast approaching vehicles or operate correctly on tight curves of radius.



The rear driving assistance system will not operate correctly whilst towing a trailer or caravan.



The correct operation of the radar sensors will be compromised if they are misaligned due to accident damage. This may cause the system to automatically shutdown.



To ensure that the radar sensors work correctly, the rear bumper should be kept free of snow and ice and must not be covered.



Use of non recommended materials or paint on rear bumper repairs may have a detrimental effect on the operation of the rear sensors. Please only use recommended materials.

Switching the System Functions On/Off

The rear driver assist system function and sub system switches can be accessed via the infotainment screen. Select ON/OFF to activate/deactivate the system.

Note: *When towing mode is active, rear parking aid system and rear driving assistance system will be disabled.*

Blind Zone Safety Assist

Blind Spot Detection

Blind Zone Safety Assist consists of two active safety assist functions: Blind Spot Detection (BSD) and Lane Change Assist (LCA), which are designed to alert the driver to vehicles that may be hidden or obscured from their sight when carrying out a maneuver.

Blind Spot Detection (BSD) alerts the vehicles in the vehicle's blind spot (1 as shown), Lane Change Assist (LCA) alerts the rapidly approaching vehicles on the adjacent left or right lane (2 as shown).

STARTING & DRIVING

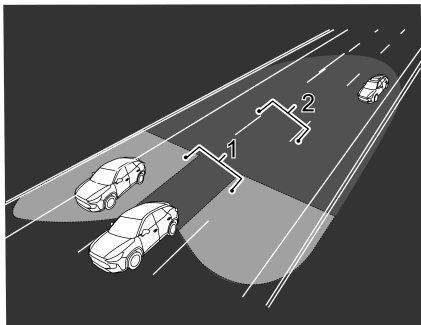

Alarm Mode

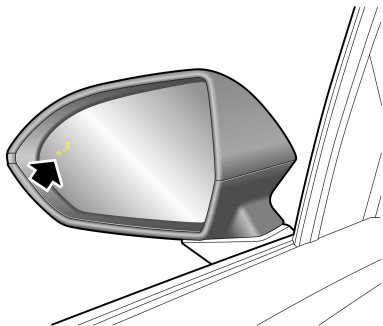

When the system detects that there is a vehicle in the blind zone of the exterior rearview mirror or a vehicle approaching behind in the adjacent lane while the vehicle speed exceeds 10 mph (15 km/h), the warning lamp on the corresponding side will illuminate. If the indicator lamp on the same side is turned on at this time, the warning

lamp will flash to remind the driver that it is dangerous to continue changing lanes.

Note: *The warning lamps will not be illuminated when the vehicle speed is significantly faster than the overtaking of the motor vehicle in the blind zone.*

Rear Cross Traffic Assist

Rear Cross Traffic Functions

Rear Traffic Assist includes the Rear Cross Traffic Alert (RCTA) and Rear Cross Traffic Braking (RCTB).

When reversing, the Rear Cross Traffic Alert (RCTA) monitors the approaching vehicles at the left/right rear by using sensors and issues an alarm when the vehicle is at risk. The Rear Cross Traffic Braking (RCTB) is an extension of the Rear Cross Traffic Alert (RCTA), which will perform emergency braking to avoid collision if the driver does not take safety measures based on the alarm.

STARTING & DRIVING

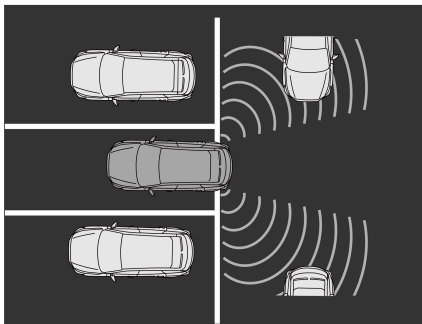

Alarm Mode

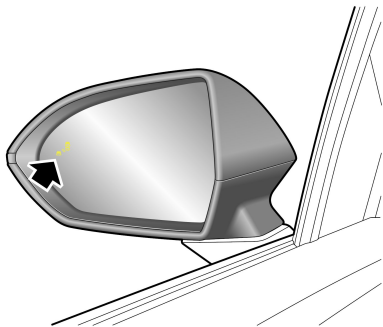

If there is a risk while reversing, the warning lamp on the corresponding side will illuminate, and a warning triangle is displayed on the infotainment display. If the driver does not take safety measures, the system will perform emergency braking.

Rear Collision Warning

Rear Collision Warning Functions

When there is another vehicle or object in the same lane, which may result in a Rear Collision Warning (RCW) will activate. The RCW system will sound a alarm and activate the brake lights to warn vehicles behind.

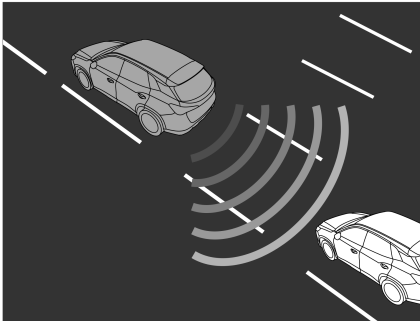

Alarm Mode

When there is a risk of collision, the instrument pack interface will give prompt warning message along with an alarm sound. The rear direction indicator lamps of the vehicle flash to warn the vehicles behind.

STARTING & DRIVING

Door Opening Warning

Door Opening Warning Functions

Whilst the vehicle is stationary, the door opening warning system monitors the surrounding area for approaching vehicles, motorcycles and bicycles. If the approaching object meets the conditions programmed into the system the corresponding warning lamps will illuminate, subsequently, if the door is opened, the corresponding warning lamps will flash accompanied with an alarm sound to warn the occupant of the approaching object and assist in avoiding any collisions .

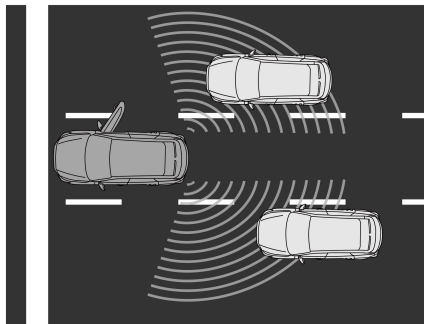

Alarm Mode

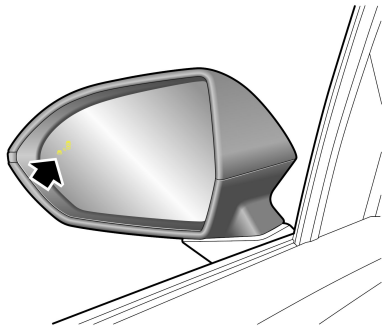

When there is a risk of collision, the warning lamp on the corresponding side will illuminate. If the door continues to be opened at this time, the warning lamp will flash with an alarm sound.

STARTING & DRIVING

Tyre Pressure Monitoring System (TPMS)



TPMS can not replace routine maintenance and checks of the tyre condition and pressure.



Using equipment that transmits on frequencies similar to that of the TPMS may interfere with the operation of the Tyre Pressure Monitoring System, this may illuminate a warning or register a temporary fault.

TPMS uses pressure sensors built into tyre valves to continuously monitor pressure and transmit data to the ECU inside the vehicle using RF signals. If it deduces that the pressure of that tyre has fallen below the predefined limit of the system, the warning light in the instrument pack will illuminate (always yellow). For more information, please refer to 'Instrument Pack' in 'Instruments and Controls' section. TPMS can remind you of low tyre pressure, but it can not replace normal tyre

maintenance. For tyre maintenance, please refer to 'Tyres' in 'Maintenance' chapter.

Note: TPMS only warns of low tyre pressures, it does not re-inflate the tyre.



If the TPMS malfunction indicator lamp illuminates, and the warning message "XX Tyre Pressure Low" is displayed, it is advised that you please stop the car as soon as possible, check the tyre pressure when they are cold and inflate the tyre to the standard pressure value. The tyre pressure label attached to the B pillar indicates the standard pressure value required by your vehicle tyres when they are cold.

Driving with under-inflated tyres may overheat and cause tyre fault. Over or under-inflated tyres wear out more rapidly and also have a detrimental effect on the car's handling characteristics. Under-inflated tyres increase the rolling resistance of the car which, in turn, increases power consumption.

TPMS Self-learning

When replacing a TPMS sensor and receiver, or performing tyre rotation, the TPMS self-learning is required, please consult a local MG Authorised Repairer for details.

STARTING & DRIVING

Load Carrying



DO NOT exceed the gross vehicle weight or the permitted front and rear axle loads. Failure may result in vehicle damage or serious injury.

Loadspace Loading



Ensure that the rear seat backrests are securely latched in the upright position when loads are carried in the load space behind the seats.

When luggage is carried in the load space, always ensure heavy items are placed as low and as far forward as possible, so as to avoid cargo shift in the event of an accident or sudden stop.

Drive carefully and avoid emergency braking or hard acceleration when loaded with large or heavy articles.

IMPORTANT

Traffic regulations must be observed when loading cargo, if the cargo extrudes the loadspace appropriate warning measures must be taken to warn other road users.

Internal Loading



DO NOT carry unsecured equipment, tools or luggage that could move, causing personal injury in the event of an accident, or emergency braking or hard acceleration.



DO NOT obstruct the driver's or passenger's vision with loads.

Folding the rear seats can increase luggage space, refer to “Rear Seats” described in the “Seats and Restraints” section.

When cargo is loaded in the vehicle, place it at a position as low as possible and ensure that it is tightly secured, so as to avoid personal injury caused by cargo movement when traffic accidents or emergency braking occurs. If the cargo has to be placed on a seat, then the seat must not be used by an occupant during that time.

General Towing Safety

Your vehicle can tow a trailer if you carefully observe load limits, use approved equipment, and follow the towing guidelines. Always check load limits before towing.

Towing loads in excess of the maximum towing weight can seriously affect vehicle handling and performance, this could damage your vehicle's engine and drive-train.

Note: Exceeding any load limits advised by MG Motor is dangerous. Consult the recommended load limits and loading prior to any journey.

Check the loading of your vehicle and trailer carefully before starting to drive.

Trailer hitch load should never exceed the limit advised by MG Motor.

Note: Excessive towing loads reduce front tyre traction and steering control, too little trailer nose load can make the trailer unstable and cause it to sway.

When adding a coupling / towing device to the vehicle:

When towing: All rear vehicle lights shall remain visible to road users behind the vehicle and shall not be

STARTING & DRIVING

obscured/partially obscured.If when towing light sources are obscured a secondary lighting source shall be used such as a lighting board.

When not towing: The fitted towing device shall not obscure any lighting source.If the towing device obscures or partially obscures a lighting source such as the fog lamp it must be removed or retracted when not towing.

Tow bars: Only genuine MG approved tow bars should be fitted to your vehicle. Only use the attachment method specified by the vehicle manufacturer for securing the towing hitch. Contact your authorised MG dealer for more information.

Safety chains: Safety chains must be used as a precautionary measure should the trailer become unintentionally unhitched. Make sure the safety chain is securely attached to both the trailer and the vehicle prior to departure.

Altitude: Your engine delivers less power at higher altitude. If you tow a trailer in a mountainous area you should reduce the combined vehicle and trailer weight by 10 % for every 1000 m of elevation.

Gradients: Where possible, when towing, you should plan your journey to avoid steep gradients. The advised brake towing mass stated assumes a maximum gradient capability of 12 %. Where possible it is recommended you drive on gradients less than 12 %. Follow the trailer associations recommendations for suitable roads.

Running in period: Avoid towing a trailer during your vehicles first 650 miles(1000 km).

Alarm System

Your car is fitted with an electronic anti-theft alarm and power immobilisation system. To ensure maximum safety and operation convenience, we strongly recommend you to carefully read this chapter to fully understand the activation and deactivation of anti-theft systems.

Power Immobiliser

Power Immobilisation is designed to safeguard the vehicle from theft. The power immobilisation system can only be deactivated to start the car by using the matched key. Once a valid key is detected in the vehicle the immobilisation system will be deactivated automatically.

If the message centre displays "Smart Key Not Detected" or "Put Key Into Back-up Position" or the power immobiliser system warning lamp illuminates, please put the smart key at Alternative Starting position (refer to "Alternative Starting Procedure" in "Starting and Stopping the Power System" section), or try to use the spare key.

If the car can still not be started, please contact MG Authorised Repairer.

STARTING & DRIVING

Anti-theft System

Locking and Unlocking

When the vehicle is locked, the remove indicator lamps flash three times; when it is unlocked, the remove indicator lamps flash once.

Operation of Door Lock System (Key)

Key Locking

- Using the remote key to lock: press the lock button on the remote key to lock the vehicle after closing the doors, bonnet and tailgate.
- Using the mechanical key to lock: partially operate the door release handle, using a suitable flat blade tool, insert the tool into the underside of the trim and carefully remove the door lock trim cover, insert the key into the driver door lock and turn counter clockwise to lock the car.

Key Unlocking

- Using the remote key to unlock: press the unlock button on the key to unlock the car.

- Using the mechanical key to unlock: partially operate the door release handle, using a suitable flat blade tool, insert the tool into the underside of the trim and carefully remove the driver door lock trim cover, insert the key into the driver door lock and turn clockwise to unlock the car.

Find My Car

After the vehicle has been left in a locked condition for a few minutes pressing the lock button again on the remote key will enable the Find My Car function. This function will identify the car by means of an audible and visual alert. Pressing the Lock button on the handset again will suspend this operation. Pressing the Unlock button will cancel this operation. Find My Car function can be set in the "Vehicle Settings" interface on the Infotainment system display.

Note: *When the complete vehicle is locked, press the UNLOCK button on the key and perform no other operations for a period of time, the vehicle will automatically lock.*

Operation of Door Lock System (Keyless)

The keyless entry system can lock and unlock the doors or open the tailgate as long as the smart key is present as you approach the vehicle.

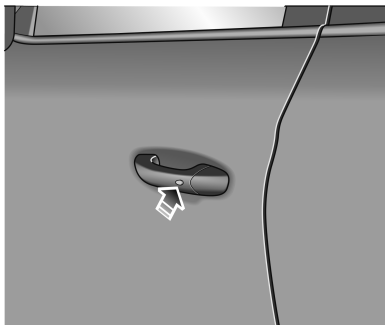

Note: Keep the distance between the smart key and the door handle within 1.5 m range in order to lock and unlock the doors in a keyless way.

Keyless Locking

After the vehicle is stopped, all doors can be locked simply by pressing the button on the front door handle once (no need to press the lock button on the remote key) when closing the doors and leaving the vehicle, and then the vehicle will enter the anti-theft alarm state.

Keyless Unlocking

Press the button on the front door handle once to unlock the vehicle, then pull the door handle to open the door.

Note: When the vehicle is locked, if you are within the smart key range and operate the door handle button, but carry out no further action, after 30 seconds the vehicle will automatically re-lock itself to remain secure.

IMPORTANT

After the door is locked by using the key, press the button on the door handle to unlock the vehicle. If the vehicle can not be unlocked or locked normally, please contact a local MG Authorised Repairer.

STARTING & DRIVING

Mislock

If the driver's door is not fully closed when the smart key lock button is pressed, the vehicle horn will sound once, indicating a mislock. In this case, none of the doors will lock, the alarm system will not be armed.

If the driver's door is closed, the passenger door, bonnet or tailgate are not fully closed, the horn sounds once to indicate mislock when the car undergoes locking operation. However, the 'partial arming' attributes of the security system will enable as much of the system to be armed as possible (all fully closed doors, bonnet or tailgate apertures will be protected, but an open door will not!). The alarm indicator will flash. As soon as the open aperture is closed, the system will automatically revert to an armed state.

Anti-theft Alarm Sound

If the anti-theft alarm has been triggered, the vehicle horn will sound continuously. Press the UNLOCK button on the remote key, the anti-theft alarm will be deactivated.

Interior Lock and Unlock Switch

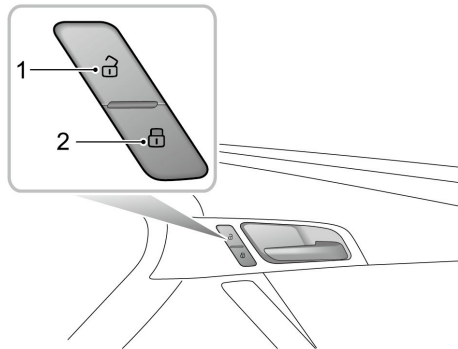

1 Unlock Switch

2 Lock Switch

When the body anti-theft system is not set, press the interior lock switch (2 as shown) after closing all doors to lock all doors; press the unlock switch (1 as shown) to unlock all doors.

Note: *If the vehicle anti-theft system is set, pressing the lock/unlock switch of interior locks will not lock/unlock doors but will trigger the alarm system.*

If the doors, bonnet and tailgate are closed, press the interior lock switch, the yellow indicator on the lock switch illuminates.

If any door other than the driver side, bonnet or tailgate is not fully closed, press the interior lock switch, the yellow indicator on the lock switch flashes.

Interior Door Handles

Pull the interior door handle to unlock and open the door.

Speed Lock

All the doors will be locked automatically when the vehicle speed exceeds 10 mph (15 km/h).

Manual Tailgate



If the tailgate can not be closed or the weatherstrip between the body and tailgate is fractured, be sure to close all windows during driving, select the face distribution mode of the air conditioner, and set the blower to maximum speed, so as to decrease exhaust fumes entering the vehicle.

STARTING & DRIVING

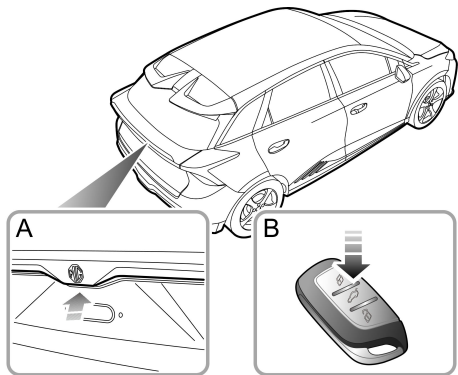

The manual tailgate can be opened using the following 2 methods:

- 1 When the vehicle is unlocked or the matched key appears within 1 m range around the tailgate, directly press the release switch (Figure A) on the tailgate to open the tailgate.

- 2 Long press the tailgate open button on the key (Figure B) for more than 2 seconds to unlock the tailgate. Then the tailgate can be lifted open.

Emergency Tailgate Opening

Tailgate emergency open switch is located in the inner side of tailgate lock.

Fold down the rear seat to make sure the emergency open keyhole plug on the tailgate trim plate can be touched.

Remove the plug, and rotate the emergency open knob counterclockwise to open the tailgate from inside.

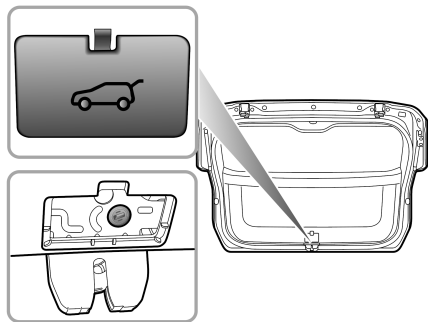

Emergency Information

252 Hazard Warning Devices

253 Vehicle Recovery

257 eCall - SOS Emergency Assistance

259 Emergency Starting

262 Tyre Repair

269 Fuse Replacement

277 Bulb Replacement

EMERGENCY INFORMATION

Hazard Warning Devices

Warning Triangle

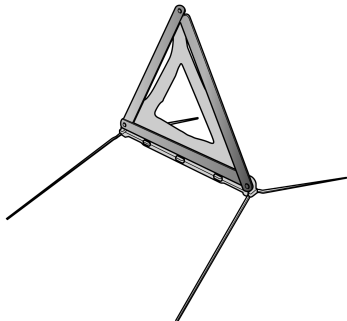

The warning triangle supplied with your vehicle is stowed in the loadspace.

If you have to stop your vehicle on the road in an emergency, you must place a warning triangle approximately 50 ~ 150 metres directly behind the vehicle

if possible, and press the hazard warning switch to warn other road users of your position.

Vehicle Recovery

Towing for Recovery



DO NOT tow the vehicle with any of the driving wheels in contact with the road surface, this will avoid electric drive transmission damage. When it is necessary to temporarily push or tow the vehicle from a dangerous situation or onto the transporter, the speed must remain below 3 mph and be completed within 3 minutes.



When pushing or towing the vehicle for temporary situation, the driver's side seat belt should be inserted into the lock and maintained in the inserted state, and then place the electric drive transmission in Neutral in order to release the EPB, otherwise the vehicle may be damaged.

Towing Hook



DO NOT use a tow rope that is twisted - or the towing hook may be unscrewed.

EMERGENCY INFORMATION

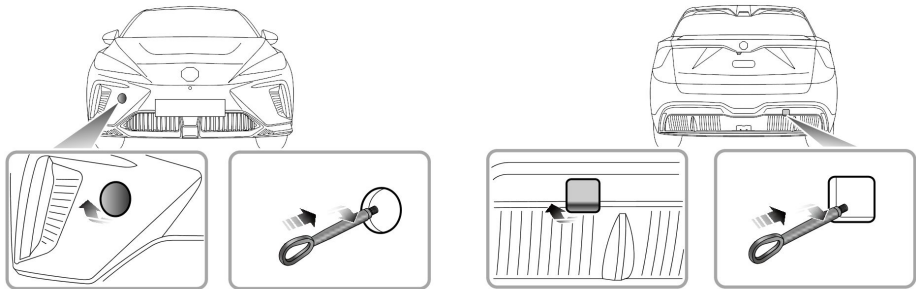

Your vehicle is equipped with 2 towing eyes (located at the front and the rear of the vehicle), which are used for fitting the towing hook in the tool kit. The tool kit is placed beneath the loadspace floor. To fit the towing hook, remove the small cover set into the bumper, first press one end of the small cover plate, then open the small cover plate after the other end is lifted, then screw in the towing hook via the small hole into the threaded hole in the bumper beam (see illustration). Ensure the towing hook is fully tightened!

Note: The towing eye cover may be secured to the bumper by a plastic cord.

Both towing points are intended for use by qualified recovery specialists to assist in the recovery of your vehicle when a breakdown or accident occurs. They are not designed for towing other vehicles, and must NEVER be used to tow a trailer or caravan. The vehicle can be towed using a tow rope but a towing bar is recommended.

Towing for Recovery



When towing, DO NOT accelerate or brake suddenly, this can cause accidents.

Suspended Towing



When using suspended towing, be careful not to let the high voltage battery pack touch the ground.

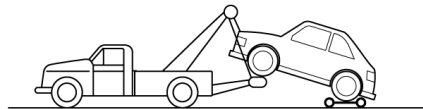
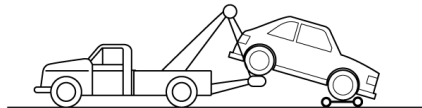

Suspended towing is the best method for recovering a vehicle that needs to be towed. The drive wheels **MUST** be suspended above the ground (the vehicle is driven with rear wheels). Switch the hazard warning lamps **ON**, and ensure no passengers are in the vehicle, otherwise the vehicle damage or personal injury may be caused.

EMERGENCY INFORMATION

Transporter or Trailer

If your vehicle needs to be transported on the back of a trailer or a transporter, it must be secured as illustrated:

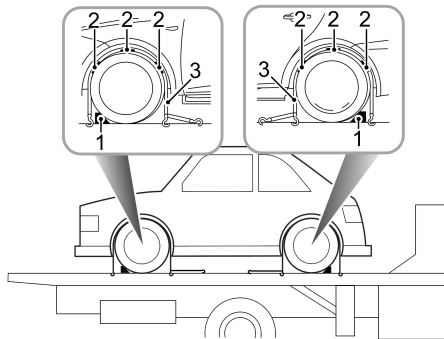

- 1 Apply the parking brake and place the electric drive transmission in park.
- 2 Fit wheel chocks (1) as shown, then position the anti slip rubber blocks (2) around the circumference of the tyre.

- 3 Fit the lashing straps (3) around the wheels and secure them to the transporter or trailer. Tighten the straps until the vehicle is securely held.

eCall - SOS Emergency Assistance

In an accident, your vehicle's eCall – SOS Emergency Assistance can either be triggered manually or in severe cases automatically upon detection by vehicle's sensors. The eCall service is a public service of general interest and is accessible free of charge. The emergency call centre will establish verbal communication with the vehicle occupants in order to understand the extent of the emergency and the level of assistance required. If verbal communication is not achievable an attempt will be made to send the following vehicle information message to the emergency call centre. The appropriate emergency services will be deployed to the vehicle's current location if known.

- Current time, location and direction of travel
- Vehicle Type
- Vehicle Identification Number (VIN)
- Whether the call was automatically or manually initiated
- Vehicle Category

This system will ensure that your personal data is securely protected. It is designed to ensure that it is not traceable and other external systems are not able to gain access.

When the eCall triggers, the system will only transmit the data information to the relevant public safety answering points designated by the respective public authorities of the country on which territory they are located, which will receive and process your emergency call request. The system will retain data locally within 13 hours of triggering.

You have the right to access the data information stored in this system, and to request the rectification, erasure or blocking of data information that does not meet the requirements of the regulations. When you think your personal data is infringed, you have the right to complain to the competent data protection authority.

For manual activation, press and release the SOS button in the overhead console for about 1 second to activate an emergency services call. A single beep will be heard when the eCall is triggered and a message will be displayed on the vehicle's message centre and entertainment player. The entertainment player will be muted whilst the emergency services call is active. Manually triggered emergency services calls may be cancelled by pressing and releasing the SOS button again within about 5 seconds of the initial press, and the messages will be removed.

EMERGENCY INFORMATION

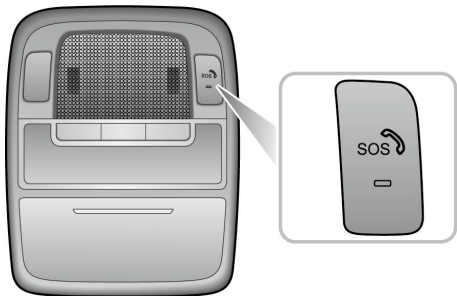

The emergency services call (eCall) system will perform a self-test when the vehicle is powered ON. During a Self-Test the emergency services call (eCall) LED status indicator on the SOS button will flash quickly until completion. The LED status indicator will illuminate permanently if no system faults are present. The LED status indicator will be extinguished or flash slowly if a fault is detected. Faults detected during the self-test will be displayed on the vehicles message centre.

Note: The operation of eCall - SOS Emergency Assistance relies on cellular coverage and may be affected by signal outages or low signal strength.

Note: The automatic emergency services call (eCall) function may be disabled by a local MG Authorised Repairer upon request.

Note: It is strongly recommended the eCall function is not disabled, any action requested by the owner must be accompanied by a signed request.

Emergency Starting



NEVER attempt to power the vehicle by pushing or towing.



Make sure that both batteries are of the same rated voltage (12 volts), and that the booster cables are approved for use with 12 volt car batteries.



Ensure sparks and open flames are kept well away from the front compartment.



Ensure that booster cables are firmly connected and do not touch each other or other moving parts, otherwise, sparks may be caused, resulting in fire or explosion.

When the battery loses power, booster cables can be used to connect the battery of another vehicle or an external battery to start the vehicle.

Ensure the vehicle power system is turned off and switch off ALL electrical equipment on the vehicle, then follow the instructions as below:

- 1 Connect a RED booster cable between the positive (+) terminals of both batteries. Connect a BLACK booster cable from the negative (-) terminal of the donor battery (A) to a good earth point (the steering gear assembly housing or other unpainted surface, for example) on the disabled vehicle (B), as far away from the battery as possible and well away from the brake lines.

EMERGENCY INFORMATION

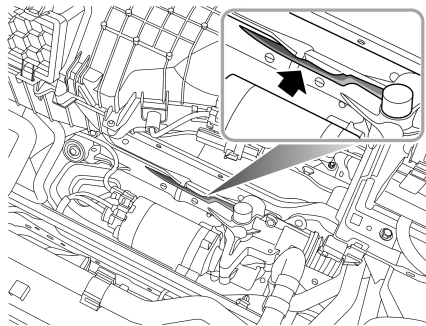
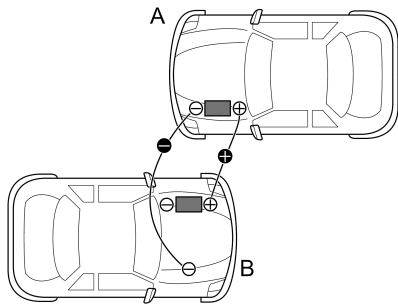

- 2 Power up or start the donor vehicle and allow it to run for a few minutes.
- 3 Power up or start the disabled vehicle. If the disabled vehicle does not power up or start after several attempts, it may need to be repaired. Please contact an MG Authorised Repairer.

- 4 After both the vehicles have normally started/powerd, turn off the START/STOP Switch of the donor vehicle.
- 5 Disconnecting the booster cables must be an exact reversal of the procedure used to connect them, i.e. disconnect the BLACK cable from the earth point on the disabled vehicle FIRST.

IMPORTANT

DO NOT switch on any electrical appliance in the disabled vehicle until the booster cables have been disconnected.

Note: *It is recommended to turn off lighting, air conditioning and other comfort appliances, and ensure that the disabled vehicle remains powered or runs for more than 1~2 hours after it is started, in order to recover the battery power. If the vehicle still fails to start/power normally after full charging, please contact an MG Authorised Repairer.*

EMERGENCY INFORMATION

Tyre Repair

The vehicle is equipped with low wind resistance wheel trim covers, which are fixed by snaps. If you need to remove or install the wheel trim cover, please pay attention to the following precautions:

- 1 When removing the trim cover, it's better to pull the trim cover apart at several positions similar to 1 (see illustration). Please **DO NOT** pull the trim cover at other positions to avoid damaging it;
- 2 When removing the trim cover, pull the 5 best pulling points one by one, and remove the wheel trim cover as a whole after all of them are pulled apart;
- 3 When installing the trim cover, ensure that the valve can be exposed from the hollow. And then clamp the trim cover in place.

Note: *When the new vehicle leaves the factory, the dust cap of the valve may be a little tight. It is recommended that you remove the wheel trim cover first during the first inflation operation, and then screw off the dust cap when there is enough space.*

Note: *If the pulling force required to remove the wheel trim cover is large, use a suitable tool to pull it out.*

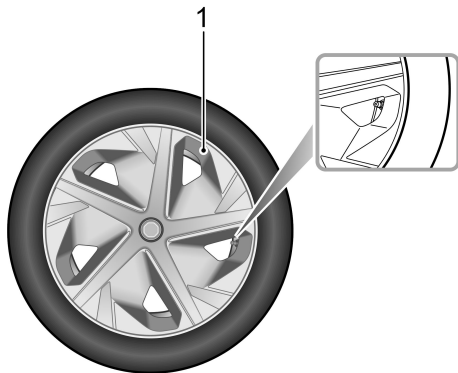

Tool Identification (including tyre repair tool)

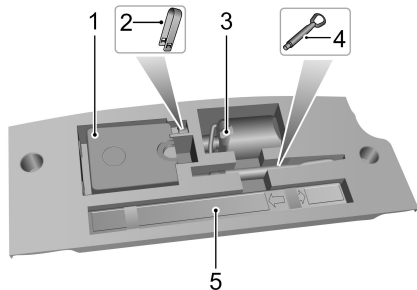

- 1 Electric Air Pump
- 2 Wheel Bolt Cap Removal Tool
- 3 Repair Fluid
- 4 Towing Hook
- 5 Warning Triangle

Tyre Repair

- 1 Remove the label at the bottom of the repair fluid reservoir and attach it to the steering wheel to remind the driver not to exceed 50 mph.

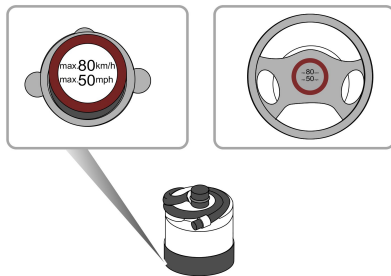

- 2 Connect the air hose of the electric air pump to the repair fluid reservoir, fit the repair fluid reservoir bottle (upright) into the slot on the compressor. Remove the valve dust cap of the flat tyre, and connect the filler hose from the repair fluid reservoir bottle to the tyre valve. Ensure that the power switch of the

EMERGENCY INFORMATION

electric air pump is in switched off (i.e., press " O "), then insert the plug from the electric air pump into the centre console power socket, and turn the vehicle power system on.

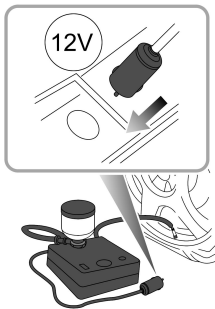

Note: To avoid battery discharge, it is recommended to keep the vehicle in P and READY mode.

- 3 Switch on the power switch of the electric air pump (i.e., press " - "), to start pumping sealant into the tyre.

The repair fluid reservoir bottle will become empty after approximately 30 seconds. The tyre should reach the specified pressure within 5 or 10 minutes.

Note: The pressure gauge may briefly reach 600 kPa (i.e. 6 bar), then the pressure begins to drop to normal.

- 4 When the required pressure is reached, switch off the electric air pump (i.e., press " o ").

Note: If the required pressure cannot be reached within 10 minutes, please disconnect the compressor, drive the vehicle 10 metres approx forward or backward to allow the sealant to spread within the tyre. If the required pressure can still not be reached, the tyre is severely damaged and you should seek assistance from the Roadside Assistance company or an MG Authorised Repairer.

Note: Continual operation of electric air pump for more than 10 minutes may result in damage to the compressor.

- 5 Remove the tyre sealant bottle from the slot, and disconnect the hose of the tyre sealant bottle from the

EMERGENCY INFORMATION

tyre valve. Then remove the plug of the electric air pump from the centre console power socket, return the tyre repair kit to its stowage tray.

- 6 After successfully adding sealant to the tyre, drive immediately for a short time (around one minute). This will allow the sealant to distribute evenly inside the tyre. Continue driving and do not exceed 50 mph. After a further 10 minutes, find a safe place to stop and recheck the tyre pressure.

Please follow different guidelines based on the tyre pressure measured:

If the tyre pressure has dropped to less than 80 kPa (0.8 bar), do not continue driving, seek assistance instead.

If the tyre pressure is between 80 kPa (0.8 bar) and the specified pressure, connect the hose of the electric air pump to the tyre valve, and inflate the tyre until it reaches the specified pressure. Repeat Step 6 .

If the tyre pressure has not dropped, you may continue driving, but the vehicle speed must not exceed 50 mph, and the driving mileage must not exceed 120 miles.

Note: *DO NOT* remove foreign objects (eg. screws, nails) from the tyre. The tyre repair system must only be used when the foreign object is in the tread pattern (A), *DO NOT* attempt a repair when the damage is in the sidewall of the tyre (B).

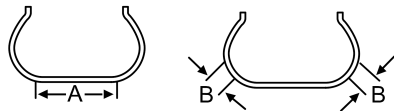

EMERGENCY INFORMATION

Changing a Wheel *

If you need to change the wheel during the journey, choose a safe place to stop away from the main road if possible. Always ask your passengers to get out of the car and wait in a safe area away from other traffic.

Switch on hazard warning lamps. If available, position a warning triangle about 50 to 150 metres behind your vehicle to warn approaching traffic.

Before changing a wheel, ensure the front wheels are in the straight ahead position. Apply the parking brake and place the gear shift lever in P position. Ensure the vehicle is powered off.

Positioning the Jack



DO NOT work underneath the car with a wheel changing jack as the only means of support. The jack is designed for wheel changing only!



NEVER jack the car using any positions other than the jacking points, otherwise serious damage may be caused.



Avoid accidental contact with any underbody parts.

Position the jack on firm level ground under the jacking point nearest the wheel to be removed. Turning the jack screw handle by hand, adjust the jack until the jack head fits snugly onto the flanging of the body.

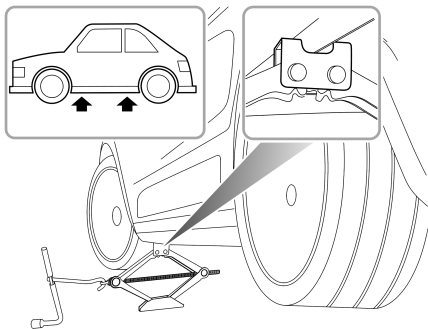

Ensure that the base of the jack is in full contact with the level ground.

IMPORTANT

- Ensure the jack is positioned on firm, level ground.
- If the vehicle must be parked on the hill, place chocks in front of and behind other 3 wheels to prevent the vehicle moving.

Fitting the Spare Wheel



Regularly check the spare wheel tyre pressure, it may be underpressure due to unused for long periods of time. Always check the tyre pressure after changing a wheel.



The wheel bolts must be tightened to the specified torque after changing a wheel (120 ~ 130 Nm).

- 1 Before raising the car, remove each wheel trim cover first. Then use the wheel bolt spanner to slacken each bolt half a turn anti-clockwise.
- 2 Turn the handle in a clockwise direction until the tyre is clear of the ground.

Note: *For your safety, place the spare tyre under the body flange near the jack, and avoid placing wheels face down on the ground - the surface may be scratched.*

- 3 Remove the wheel bolts and put away to prevent them from being lost. Make sure the vehicle is steady and

EMERGENCY INFORMATION

there is no risk of slip or movement before removing wheel bolts.

- 4 Remove the road wheel.

Note: Place the replaced spare tyre under the body flange near the jack, and avoid placing wheels face down on the ground - the surface may be scratched.

- 5 Fit the spare wheel and tighten the wheel bolts until the wheel is seated firmly against the hub.
- 6 Lower the vehicle and remove the jack, then FULLY tighten the wheel bolts in a diagonal sequence.
- 7 Place the tools back, and put the replaced wheel in a safe place.

Note: DO NOT stand on the handle of the wheel bolt spanner or use extension tube on the handle of the spanner.

Note: When replacing the wheel, please fully tighten the bolts in the diagonal sequence twice.

Note: Please contact an MG Authorised Repairer to replace with a new tyre.

Fuse Replacement

Fuse

Fuses are simple circuit breakers that protect the car's electrical equipment by preventing the electrical circuits from being overloaded. A blown fuse indicates that the circuit under its protection fails and stops working.

If you suspect a fuse is faulty, you can take it out of the fuse box and inspect it to see if the wire in the fuse is blown.

IMPORTANT

- NEVER attempt to repair a blown fuse. ALWAYS replace a fuse with one of the same rating, otherwise the fire may be caused due to electrical system damage or circuit overload.
- If a replaced fuse fails immediately, please contact a local MG Authorised Repairer for service as soon as possible.

It is recommended to have spare fuses in the vehicle, which can be obtained from a local MG Authorised Repairer.

Fuse Box

The vehicle is equipped with 2 fuse boxes:

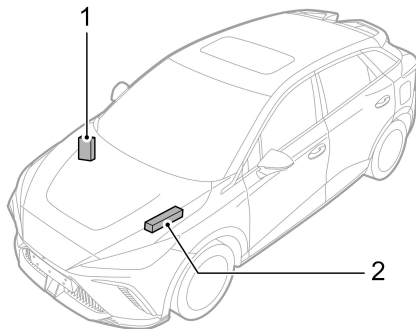

- 1 Passenger compartment fuse box (behind the driver side knee trim panel)
- 2 Front compartment fuse box (left of the engine compartment)

EMERGENCY INFORMATION

Passenger Compartment Fuse Box

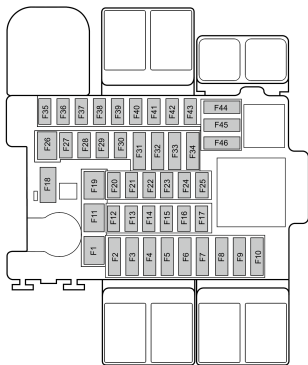

Check or Replace a Fuse

- 1 Power off the vehicle and turn off all electrical appliances, and disconnect the negative battery cable.
- 2 Remove the driver side knee trim panel to access the fuse box.

- 3 Clamp the fuse head with a fuse extraction tool in the fuse box cover of the front compartment, pull and remove the fuse, and check whether the fuse is blown.
- 4 If a fuse is blown, replace it with another fuse of the same type and same ampere value.

Fuse Specification

Code	Specs	Function
F1	-	-
F2	5A	High Voltage Electric Heater
F3	7.5A	Gateway
F4	15A	Heated Steering Wheel

EMERGENCY INFORMATION

Code	Specs	Function
F5	5A	Driver door combination switch, exterior rearview mirrors and headlamp leveling switch, EPB switch, infotainment control panel, clock spring
F6	5A	Pedestrian alert module, communication module
F7	5A	Gear shift control unit, instrument pack

Code	Specs	Function
F8	7.5A	Digital radio, central display, front view camera module
F9	5A	Charging Port
F10	-	-
F11	30A	Driver seat control module, driver seat adjustment switch
F12	-	-
F13	5A	Fatigue Monitoring Module
F14	10A	Airbag Control Module

EMERGENCY INFORMATION

Code	Specs	Function
F15	15A	Super Lock
F16-F17	-	-
F18	10A	Electronic Steering Column Lock
F19	-	-
F20	10A	DLC
F21	-	-
F22	10A	Automatic Temperature Control
F23	-	-
F24	20A	Infortainment Mainframe

Code	Specs	Function
F25	5A	Rear Driving Assistance Radar
F26-F43	-	-
F44	15A	Front Console Power Socket
F45	5A	Rear USB port, wireless charging module of mobile phone
F46	-	-

EMERGENCY INFORMATION

Code	Specs	Function
F57	5A	Electric Parking Motor Control Unit
F58	30A	Body Control Module
F59	-	-
F60	30A	Heated Rear Window
F61	40A	Integrated Braking System
F62	30A	Power Window Regulator Motor
F63	5A	Airbag control module, collision power module, instrument pack, gateway, parking assist sensor, body control module
F64	30A	Collision Power Module
F65	-	-

Code	Specs	Function
F66	10A	Electric Exterior Rearview Mirror
F67	-	-
F68	20A	Electric Parking Motor Control Unit
F69	30A	Collision Power Module
F70	5A	Integrated braking system, electric power steering, second axis motor controller, intelligent electronic control unit
F71	-	-
F72	20A	Right Headlamp
F73	5A	Battery sensor, brake pedal switch
F74-F76	-	-

EMERGENCY INFORMATION

Code	Specs	Function
F77	15A	PEB Cooling Water Pump
F78	20A	High Voltage Battery Pack System
F79	50A	Air Conditioning Inlet Box
F80	10A	Second axis motor control unit, intelligent electronic control unit
F81	15A	PEB Cooling Water Pump
F82	-	-
F83	15A	Battery Pack Coolant Pump
F84	-	-
F85	15A	Front Wiper Motor
F86	15A	Heat Pump Controller
F87	5A	Combined Charging Unit

Code	Specs	Function
F88	5A	Electric air conditioning compressor, battery pack heater
F89	5A	Interior rearview mirror, exterior rearview mirrors and headlamp leveling switch, left headlamp, right headlamp
F90	-	-
F91	30A	Body Control Module
F92	25A	Wiper Relay
F93	30A	Automatic Window Regulator Motor
A	-	-
B	-	-
C	80A	Electric Power Steering
D	-	-

EMERGENCY INFORMATION

Code	Specs	Function
E	100A	Passenger compartment fuse box
F	-	-
G	60A	Cooling Fan Power Supply
H	60A	Integrated Braking System

Bulb Replacement

Bulb Specification

Bulb	Specifications
Front Reading Lamp	W5W 5W
Front Direction Indicator Lamp (Standard and Comfort Model)	WY21W 21W
Rear Direction Indicator Lamp	WY21W 21W
Reverse Lamp	W21W 21W
Rear Fog Lamp	W21W 21W

Note: Other light sources not included in the list are LED, which cannot be replaced individually.

Replacement

Before replacing any bulb, be ensure the vehicle and lighting switch are both powered OFF to avoid any possibility of a short circuit. When replacing the bulb,actions should be gentle so as not to damage the lamp. MG only recommends

replacement bulbs that completely meet the manufactures specifications.

Note: Only replace bulbs with the same type and specification.

Note: If the bulb glass is scratched or contaminated, it may cause issues with the projected light pattern. Take care NOT to touch the glass with your fingers; If necessary, clean the glass with methylated spirits to remove fingerprints.

If in doubt when replacing bulbs, contact an MG Authorised Repairer.

EMERGENCY INFORMATION

Front Reading Lamp

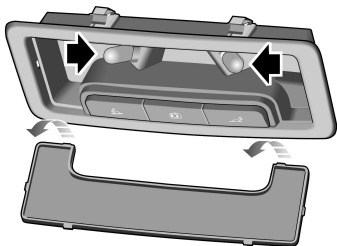

- 1 Disconnect the battery negative terminal.
- 2 Gently pry the lens from the lamp assembly with flat-bladed screwdriver.
- 3 Remove the bulb from its mounting to remove.
- 4 Install new bulb.
- 5 Install the lens, locate the two prongs at the front of the lens and then carefully flex the lens to locate the two prongs at the rear of the lens into the light unit. Push the lens upwards until it 'clicks' into position.
- 6 Reconnect the battery negative terminal.
- 7 Test lamp operation.

Front Direction Indicator Lamp *

- 1 Open the bonnet.
- 2 Disconnect the battery negative terminal.
- 3 Rotate the front direction indicator bulb holder anti-clockwise to remove from the lamp unit and remove bulb.

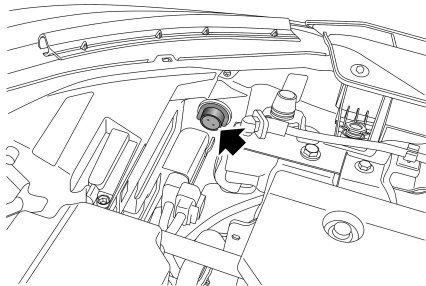

- 4 Fit new bulb to bulb holder.

- 5 Insert bulb holder in lamp assembly, rotate clockwise until fully secure.
- 6 Reconnect the battery negative terminal.
- 7 Test lamp operation.
- 8 Close the bonnet.

EMERGENCY INFORMATION

Rear Direction Indicator Lamp & Reverse Lamp

- 1 Open tailgate.
- 2 Disconnect the battery negative terminal.
- 3 Carefully remove the two covers on tail lamp trim panel with a suitable pry bar or lever, .

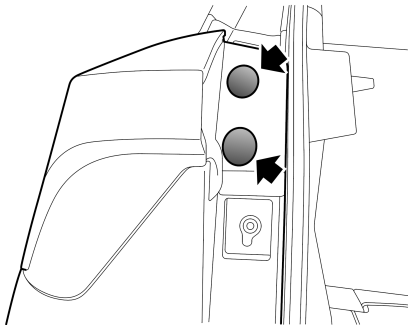

- 4 Using a suitable spanner or socket wrench to remove 2 bolts fixing the tail lamp to the body.

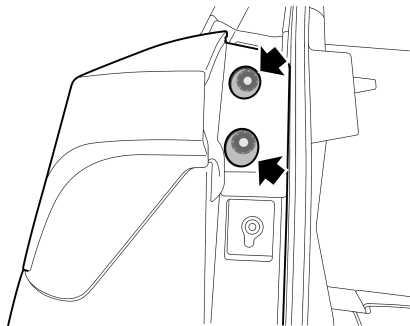

- 5 Disconnect the harness connector and remove the tail lamp.
- 6 Rotate the rear turn signal lamp holder (1) or reverse lamp holder (2) in anti-clockwise, remove the bulb holder and remove the bulb.

EMERGENCY INFORMATION

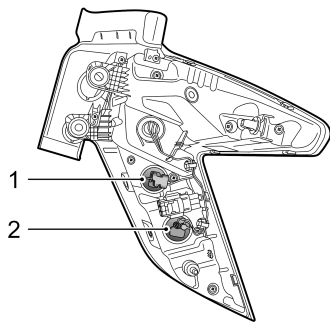

- 7 Fit new bulb to bulb holder.
- 8 Insert the bulb holder in tail lamp assembly, rotate clockwise until fully secure.
- 9 Ensure lamp seal is correctly located.
- 10 Connect the harness connector, position lamp to body, start 2 bolts fixings, and tighten to 3 - 5 Nm.
- 11 Refit two bolt cover trim.

- 12 Reconnect the battery negative terminal.
- 13 Test lamp operation.
- 14 Close tailgate.

EMERGENCY INFORMATION

Rear Fog Lamp



DO NOT replace the rear fog lamp bulb when charging.

- 1 Open tailgate.
- 2 Disconnect the battery negative terminal and then keep the vehicle to stand for at least 1 min.

Note: Ensure the standing time of the vehicle for the current release of high-voltage components to avoid the risk of electric shock.

- 3 Safely raise and support the front of the vehicle with suitable support equipment. DO NOT work under a vehicle that is only supported by a scissor or trolley jack.
- 4 Using a suitable spanner or socket wrench to remove the rear bottom deflector to gain access to the fog lamp.

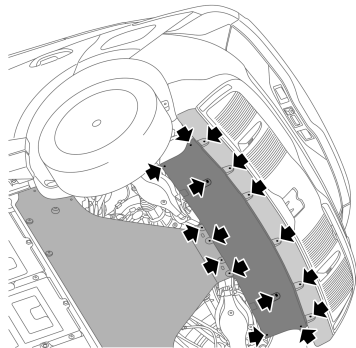

- 5 Rotate the bulb holder anti-clockwise (as illustrated) and remove the bulb.

Note: DO NOT touch any high-voltage components (2), when replacing the rear fog lamp bulb.

Note: If there are any signs of damage to high-voltage component (2), please contact your MG Authorised Repairer before replacing the bulb.

EMERGENCY INFORMATION

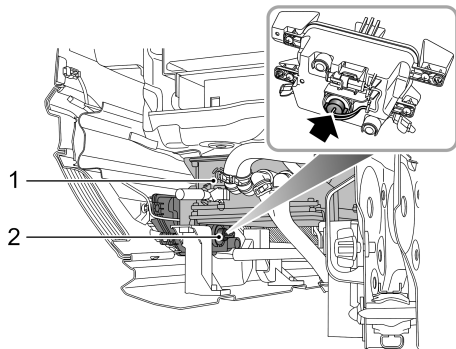

1 High-voltage Component

2 Rear Fog Lamp

- 6 Fit new bulb to bulb holder.
- 7 Insert bulb holder in lamp assembly, rotate clockwise until fully secure.
- 8 Refit the rear bottom deflector.

- 9 Connect the battery negative terminal.
- 10 Test lamp operation.

Service and Maintenance

286 Maintenance

289 Bonnet

290 Front Compartment

291 Battery

293 Cooling System

295 High Voltage Battery Pack

298 Washer

300 Wipers

302 Brake

304 Tyre

310 Cleaning and Vehicle Care

SERVICE AND MAINTENANCE

Maintenance

Routine Servicing

The safety, reliability and performance of your car will depend partly on how well it is maintained. You must ensure that maintenance is carried out when required and according to the information contained in the "Service Schedule" owners section.

Servicing

For next service information please consult your service records.

Some markets feature a service reminder in the IPK message centre.

Service History

Ensure MG Authorised Repairer registers the Service History after each service.

Brake Fluid Replacement

Replace the brake fluid according to the information contained in the "Service Schedule" owners section.

Note: *Brake fluid replacement will be an additional cost.*

Coolant Replacement

The coolant (anti-freeze and water solution) needs to be replaced according to the information contained in the "Service Schedule" owners section.

Note: *Coolant replacement will be an additional cost.*

Owner Maintenance



Any significant or sudden drop in fluid levels, or uneven tyre wear, should be reported without delay to MG Authorised Repairer.

In addition to the routine services referred to previously, a number of simple checks must be carried out more frequently. Advice is given on the pages that follow.

Daily Check

- Operation of lights, horn, wipers, washers and warning lamps.
- Operation of seat belts and brakes.

- Look for fluid deposits underneath the car that might indicate a leak.
- Check tyre appearance.

Weekly Check

- Coolant levels.
- Brake fluid level.
- Windscreen washer fluid level.
- Operate air conditioning.

Special Operating Conditions

If your car is frequently used in dusty conditions, or operated in extreme climates where sub-zero or very high ambient temperatures are normal, more frequent attention may need to be paid to servicing requirements. You need to carry out special maintenance operations (refer to Service Schedule) or contact an MG Authorised Repairer.

Safety in the Garage

Note: *Cooling fans may commence operating after the vehicle is switched off, and continue operating for a number of minutes. Keep clear of all fans while working in the front motor compartment*

If you need to carry out maintenance, observe the following safety precautions at all times:

- If the car has been driven recently, DO NOT TOUCH cooling system components until the drive motor has been fully cooled down.
- DO NOT TOUCH electrical leads or components when the power is on.

SERVICE AND MAINTENANCE

- DO NOT work underneath the car with a wheel changing jack as the only means of support.
- Wear protective clothing and work gloves.
- Remove watches and jewelry before working in the front compartment.
- DO NOT allow tools or metal parts of the car to make contact with the battery leads or terminals.

Toxic Liquid

Fluids used in motor vehicles are poisonous and should not be consumed or brought into contact with open wounds. These include: battery acid, coolant, brake fluid and windscreen washer fluid.

For your own safety, ALWAYS read and obey all instructions printed on labels and containers.

Bonnet

Opening the Bonnet



DO NOT drive when the bonnet is not closed or retained only by the safety catch.

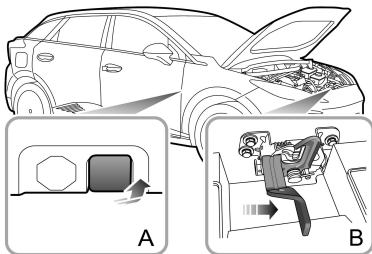

- 1 From the inside of the vehicle, pull the bonnet release handle (A).

- 2 Move the safety catch release handle on the bonnet lock assembly in the direction of the arrow (B) to release the bonnet safety catch.
- 3 Raise the bonnet and hold it up with the support rod firmly.

Closing the Bonnet

Hold the bonnet using both hands and lower it, allowing it to drop for the last 20 ~ 30 cm to fully close the bonnet.

By attempting to lift the front edge of the bonnet, check if the bonnet is fully locked after closing the bonnet. If the bonnet is not fully locked, you must repeat the closing operation.

Bonnet Open Alarm

If the bonnet is not fully locked, the corresponding alarm icon (refer to "Message Centre" in "Instruments and Controls" chapter) will be shown on the message centre display. If it is found that the bonnet is not fully locked while driving, an audible warning will sound.

SERVICE AND MAINTENANCE

Front Compartment



When operating the components in the front compartment, the safety precautions listed in "Safety in Garage" should be observed, and please refer to "Maintenance" in this section.

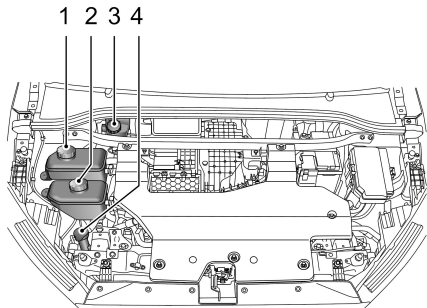

- 1 High Voltage Battery Pack Coolant Expansion Tank (Black Cap)
- 2 Electric Drive Transmission Coolant Expansion Tank (Black Cap)
- 3 Brake Fluid Reservoir (Black Cap)
- 4 Washer Fluid Reservoir (Blue Cap)

Battery

Battery Maintenance



DO NOT use on-board electrical appliances for an extended period of time when the vehicle is not started, otherwise the battery may become flat, resulting in the failure to start the vehicle or the reduction of battery life.



Always store batteries upright, and never attempt to dismantle a battery.

The battery, located in the front compartment, is maintenance-free, therefore there is no need to refill fluid.

According to current load conditions and battery status, the system may limit the power of some electrical appliances. Please ensure the vehicle is placed in READY mode as soon as possible to charge the battery.

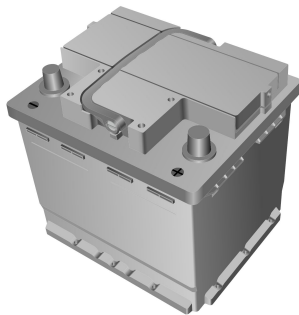

Note: It is recommended to set the power mode to **READY** for more than half an hour every week to help extend the service life of the battery. When the vehicle will not be used for an extended period (more than 1 month), it is recommended to disconnect the battery negative terminal clamping pile head. Make sure that the vehicle power system has been turned off before connecting or disconnecting the negative battery cable.

SERVICE AND MAINTENANCE

Battery Replacement



The battery contains sulphuric acid, which is corrosive.

Please contact an MG Authorised Repairer to remove and refit the battery. In order to maintain the correct vehicle functionality, it is recommended to fit a replacement battery of the same type and specification as the original.



The battery must be disposed of using an approved method, used batteries can be harmful to the environment. It should be recycled by a professional company. Please consult an MG Authorised Repairer for more details.

Cooling System

Coolant Check and Top Up



DO NOT remove the coolant pressure cap when the cooling system is hot - escaping steam or hot coolant could cause serious injury.

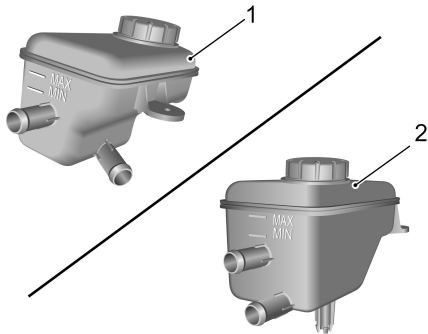

1 High-voltage battery pack coolant expansion tank

2 Electric drive transmission coolant expansion tank

The cooling system should be checked weekly when the cooling system is cold and with the car resting on level ground. If the coolant level is below the MIN " mark, open the coolant expansion tank cap and top up coolant. The coolant level should not be higher than the " MAX " mark.

Note: Prevent coolant from coming into contact with the vehicle body when topping up. Coolant will damage the paint.

If the coolant level falls appreciably during a short period, and you suspect that there may be a leak, please seek an Authorised Repairer for service.

Coolant Specification



Coolant is poisonous and can be fatal if swallowed - keep coolant containers sealed and out of the reach of children. If accidental contact of coolant by children is suspected, seek medical assistance immediately.

SERVICE AND MAINTENANCE



Prevent the coolant from coming into contact with the skin or eyes. If this occurs, rinse immediately with plenty of water. If eyes are still red, painful or uncomfortable, seek medical attention immediately.

Please use the coolant which is recommended and certified. Please refer to 'Recommended Fluids and Capacities' in the "Technical Data" section.

Note: The addition of corrosion inhibitors or other additives to the cooling system of this car may severely disrupt the efficiency of the system and cause parts damage. For cooling system issues please consult an Authorised Repairer.

High Voltage Battery Pack

Precautions and restricted conditions for use of battery



When using the vehicle on a daily basis, it is recommended to fully charge it at least once a week, which is conducive to the health maintenance of the high-voltage battery pack; every 3 months to half a year, a low-power (less than 10% or 1 grid) full charged is performed.



If the vehicle is not going to be used, parked, or stored for a long time it is necessary to charge the vehicle at least once every 3 months. During this time, the High Voltage battery state of charge should not be allowed to drop below 50%.



*If the battery is in a low state of charge and the instrument pack displays no valid driving range, the vehicle **MUST NOT** be left in a stored state for more than 7 days without being charged to above 50%.*



Failure to follow these guidelines will result in HV battery damage and invalidate the warranty.



***DO NOT** attempt to dismantle the battery pack or any High Voltage components - **THESE ARE DANGEROUS**. Any signs of dismantling or damage caused by attempts to dismantle will invalidate the warranty.*

SERVICE AND MAINTENANCE



When using a paint curing oven please observe the following: Before and after any paint baking process, the vehicle should be parked at room temperature (20 ± 2 °C) for 24 hours. The vehicle can be used normally after being parked for 24 hours. The baking oven temperature should not exceed 80 °C and the baking time should not be longer than 30 minutes.

- 1 DO NOT park the vehicle in conditions where the ambient temperature exceeds 45°C for more than 15 days. This will effect the performance and service life of the high voltage battery.
- 2 To maintain or improve the service life of the high voltage battery, it is recommended that you use a slow charging method wherever possible, rapid charging should only be used for long distance journeys or emergencies.
- 3 It is recommended using the vehicle at least once a month.
Where possible it is recommended that you carry out a slow charging (equalisation charging) every month

to extend the service life of high-voltage battery pack. The battery management system will monitor the status of the high voltage battery pack. After monitoring for a period of time, if an equalisation charge has not been carried out for some time the message centre in the instrument pack will display 'Please Slow-charge the Vehicle'. At this time you must carry out an equalisation charge. For operation mode, please refer to 'Equalisation Charging' in 'Starting & Driving' section.

- 4 When the vehicle is used for the first time or after a long period of storage, the SOC displayed on the instrument may have deviation. A fully charge is recommended before use. (Battery pack type 2)
- 5 In the event of an accident, damage to the high voltage battery or any of its related components, or any repairs made to the high voltage system the car must be inspected by qualified personel at an MG Authorised Repairer.
- 6 In the event of any accident or body repairs being required please consult the qualified personnel at an MG Authorised Repairer. The repair may require high

voltage battery isolation or specialist HV component removal.

IMPORTANT

Only fully trained and qualified personnel are allowed to work on the high voltage systems and components of this vehicle. Any disassembly of such systems or components is strictly prohibited.

SERVICE AND MAINTENANCE

Washer

Washer Fluid Check and Top Up



Windscreen washer fluid is flammable. DO NOT allow windscreen washer fluid to come into contact with naked flames or sources of ignition.



When filling the washer fluid, DO NOT let the washer fluid spill on parts around the engine, motor, electric drive transmission or on the paint surface of the vehicle body. In case the washer fluid is spilled on hands or other parts of the body, please immediately wash with clean water.

The washer fluid is used to clean the windshield. Check the washer fluid level regularly. When the level of washer fluid is low, please top up the washer fluid as instructed. Please use the washer fluid recommended and certified by the manufacturer. Refer to 'Recommended Fluids and Capacities' in 'Technical Data' chapter.

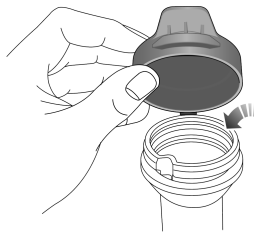

Note: DO NOT use an anti-freeze or vinegar/water solution in the washer reservoir-anti-freeze will damage paintwork while vinegar will damage the washer pump.

IMPORTANT

- Use the washer fluid recommended and certified by the manufacturer. Misuse of washer fluid in winter may cause damage to the washer motor due to freezing.
- Turning on the washer switch when there is no washer fluid may cause damage to the washer motor.
- Operating the wipers when the windscreen is dry and there is no washer fluid may cause damage to the windscreen and wiper blades. Please spray the washer fluid and start the wipers when there is adequate washer fluid.

Washer Nozzles

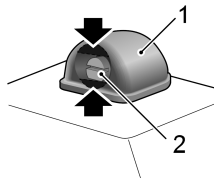

Operate the washers periodically to check that the nozzles are clear and properly directed.

The windscreen washer nozzles are configured during the production. To adjust the windscreen washer nozzle, you can insert a small flat-bladed screwdriver in the upper and bottom gaps (as indicated by the arrow) between the housing (1) and the nozzle (2) and turn downward or upward slightly to adjust to the appropriate spray angle.

If the nozzle is obstructed, insert a needle or thin metal wire into the hole to remove the obstruction.

SERVICE AND MAINTENANCE

Wipers

Wiper Blades

IMPORTANT

- Grease, silicon and petroleum products impair the blade's wiping capability. Clean the wiper blades in warm soap water, and check their status periodically.
- Clean the windscreen frequently. DO NOT use wiper blades to remove stubborn or ingrained dirt, it will reduce their effect and their life span.
- If signs of hardness or cracking in the rubber are found, or if the wipers leave streaks or unwiped areas on the windscreen, then the wiper blades should be replaced.
- Clean the windscreen regularly with an approved glass cleaner and ensure the windscreen is thoroughly cleaned before the replacement of wiper blades.
- Only fit the wiper blades that are identical to the original specification.
- Clean ice and snow from the wipers and ensure they are not frozen or otherwise, sticking to the windscreen before attempting to operate them.

Replacing Front windscreen Wiper Blades

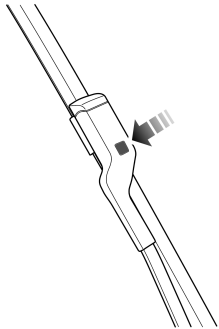

- 1 With the front hatch cover in closed state, click the icon on the large screen and select "Safety - power off" in turn within 20 seconds and then operate the wiper lever switch by pressing down to the single wipe position (see "Wipers and Washers" in the "Instruments and Controls" chapter) and releasing it, the wiper will automatically move to the service position and stop on the windscreen.
- 2 Lift the wiper arm away from the windscreen.
- 3 Press the button on the wiper arm (as illustrated), and pull the upper end of the wiper blade outward to disengage from the wiper arm.
- 4 Unhook the blade from the wiper arm and discard it.
- 5 Locate the new wiper into the slot of the wiper arm.
- 6 Push the wiper blade towards the arm until the wiper blade is engaged.
- 7 Place the wiper assembly back to the windscreen, and check whether the wiper blade is fitted correctly to the arm.
- 8 Operate the wiper lever switch by pressing down to the single wipe position again and releasing it, or power on the vehicle, the wiper will exit the service mode and automatically return to its original position.

SERVICE AND MAINTENANCE

Brake



DO NOT rest your foot on the brake pedal while driving; this may overheat the brakes, reduce their efficiency and cause excessive wear to the brake components.

The free travel of the brake pedal is 0~30 mm.

Reasonable usage scope of brake friction pair: not less than 2 mm for thickness of brake pads, 23~25 mm for front brake disc, and 10~12 mm for rear brake disc.

For the first 1500 km, you should avoid situations where heavy braking is required.

Please check all the brake system components periodically for wear at the time interval specified in the Service Portfolio, and replace them when necessary to ensure long term safety of the brake system.

The vehicle needs to run in for 800 km after brake pad or disc replacement.

Brake Fluid Check and Top Up



Brake fluid is highly toxic, keep the brake fluid sealed and stored out of reach of children. If accidental contact of brake fluid is suspected, seek medical attention immediately.



Prevent brake fluid coming into contact with the skin or eyes. If this occurs, rinse immediately with plenty of water. If eyes are still red, painful or uncomfortable, seek medical attention immediately.

Check the brake fluid level every week. When checking, the vehicle shall be parked on level ground and the system must be in cold state.

The brake fluid level can be seen through the reservoir and should be maintained between the 'MAX' and 'MIN' mark.

Note: DO NOT allow the brake fluid level to drop below the 'MIN' mark or rise above the 'MAX' mark.

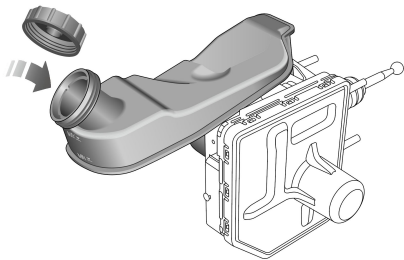

IMPORTANT

Replace brake fluid regularly according to the Service Portfolio.

Note: Brake fluid will damage painted surfaces. If you accidentally spill the brake fluid on the painted surface, soak up any spillage with an absorbent cloth immediately and wash the area with water or car shampoo.

Brake Fluid Specification

Use the brake fluid recommended and certified by the manufacturer. Refer to 'Recommended Fluids and Capacities' in 'Technical Data' chapter.

SERVICE AND MAINTENANCE

Tyre

Overview

- New tyres may not have the best adhesive ability at the beginning. Therefore, driving your vehicle at moderate speed and in a prudent way at the first 300 miles, which is also beneficial to the service life of the tyres.
- When passing kerbs or similar road sections, only drive at a slow speed, with the wheels and kerbs at right angle as much as possible.
- Regularly check tyres for signs of damage. **DO NOT** remove foreign objects such as screws or nails from the tyre. If a tyre shows any signs of damage, please ensure it is inspected by a reputable tyre fitter for advice.
- The valve dust cap must be fitted to prevent dust from entering the valve.
- If the tyre is to be removed, always mark the tyre/wheel orientation to ensure correct reinstallation.
- Store the removed wheel or tyre in a cool, dry and dark place.

The damage of a tyre or rim may happen unnoticeably. If abnormal vibration or deviation is experienced, that means

the tyre may have been damaged. If you suspect that a tyre is damaged, please slow down immediately, and stop your vehicle to check the tyre for damage. If you can't see the damage from the outside, continue driving the vehicle slowly to a nearest MG Authorised Repairer for inspection and service.

Tyres with Directional Thread Patterns

Tyres with directional thread patterns have arrows on the side to mark the direction, and it is essential to use the tyres in this 'direction of rotation' (DOR). To maintain handling characteristics, tyre performance, high adhesion properties, low road noise and extend tyre life, tyres/wheels must always be fitted with indication arrow showing the correct 'DOR'.

Tyre Life

Rational tyre pressure and moderate driving style can extend tyre life. Recommendations:

- Check the tyre pressures at least once a month, it should be carried out when the tyre is cold;
- Avoid cornering at excessive speeds;
- Check tyres frequently for abnormal wear;
- When the vehicle is to be parked for a long time, the vehicle should be moved at least once every two weeks to prevent permanent deformation of the tyres due to long-term stress.

The following factors affect the tyre life:

Tyre Pressures

Incorrect pressure will cause the abnormal wear of the tyre, greatly shorten the service life, and have an adverse effect on the driving characteristics of the vehicle.

Driving Style

Excessively harsh acceleration and braking whilst cornering will reduce tyre life.

Wheel Balance

Every new vehicle leaves the factory having had the wheels dynamically balanced. Out of balance wheels may be due to many factors.

If wheels are out of balance, shaking or vibration of the steering mechanism may occur and the tyres may start to wear excessively. It is important to restore wheel balance as quick as possible. Each wheel should be rebalanced after installing a new tyre or having a tyre repair.

Wheel Alignment

Incorrect wheel alignment can cause excessive tyre wear and affect vehicle safety. If the tyres show signs of abnormal wear, check the wheel alignment in time and seek advice from an MG Authorised repairer.

SERVICE AND MAINTENANCE

Caring for Your Tyres



USE OF DEFECTIVE TYRES ARE DANGEROUS! DO NOT drive if any tyre is damaged, excessively worn, or inflated to an incorrect pressure.



It is recommended to install the tyres consistent with the original specifications. DO NOT replace the tyres with tyres of any other type. Alternative tyres, of a different specification, may adversely affect the vehicle's driving characteristics and safety. In order to retain the original safety characteristics, it is suggested that you consult an MG Authorised Repairer.

Always drive with consideration for the condition of the tyres, and regularly inspect the tread and side walls for any sign of distortion (bulges), cuts or wear.

Note: Prevent tyres from coming into contact with oil, grease and fuel.

Tyre Pressures



Before a long distance journey, the tyre pressure must be checked.

Check the pressures at least every month, when the tyres are cold.

If it is necessary to check the tyres when they are warm, you should expect the pressures to have increased by 4 - 5 psi (i.e. 0.3 - 0.4 bar). In this circumstance, NEVER let air out of the tyres in order to match the recommended pressures (cold) in the technical data.

Valves

Keep the valve caps firmly secured to prevent dirt from entering the valve. Check the valve for leaks (listen for a tell-tale hissing) when you check the tyre pressure.

Punctured Tyres

Your vehicle is fitted with tyres which may not leak if penetrated by a sharp object, provided the object remains in the tyre. If you are aware of this occurring, reduce speed

immediately and drive with caution until the spare wheel can be fitted, or repairs undertaken.

Note: *If the sidewall of the tyre is damaged or distorted, replace the tyre immediately, do not attempt to repair it.*

Tyre Wear Indicators

The tyres fitted as original equipment have 1.6 mm-high wear indicators at their tread pattern bottom, vertical with the wheel rolling direction and evenly distributed around the circumference. The mark on the tyre side such as capital letters TWI or triangular symbol shows the location of wear indicator.

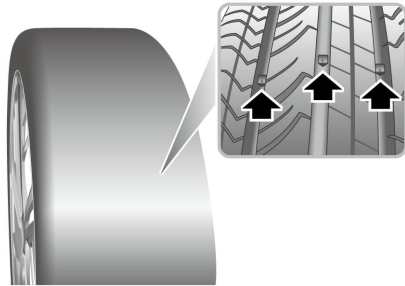

When the tread has worn down to 1.6 mm or below, the indicators will come to the surface of the tread pattern, producing the effect of a continuous band of rubber across the width of the tyre.

IMPORTANT

A tyre **MUST** be replaced as soon as a wear mark becomes visible. Otherwise there may be a risk of accidents.

SERVICE AND MAINTENANCE

Tyre Rotation

It is recommended that you swap wheels at irregular intervals in order to equalise tyre wear.

When the tyres are worn seriously, it is recommended to swap the front and rear wheels as shown in illustration. This can prevent tyres from uneven wear, prolong the life span and balance tyre fatigue.

It is favorable to swap the driving wheels from front to rear and exchange non-driving wheels across.

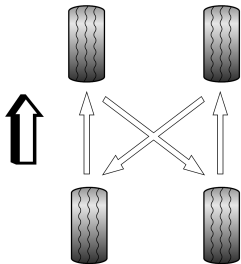

Note: Directional tyres are marked with 'direction of rotation' (DOR). To maintain driving characteristics, tyres must always be fitted with indication arrow showing the correct 'DOR'. When the tyre tread pattern is directional, the wheels must not be exchanged diagonally or left to right but can be exchanged front to rear.

Note: TPMS coding is required after changing wheel positions, please consult a local MG Authorised Repairer for details.

Tyre/Snow Chains

Unsuitable tyre/snow chains may damage the tyres, wheels, suspension, brakes or bodywork of your vehicle.

Please pay attention to the following requirements in the usage:

- The tyre/snow chains can only be fitted on the drive wheels;
- The thickness of tyre/snow chains shall not exceed 15 mm;
- Please always observe the installation and tension instructions for the tyre/snow chains, as well as the speed limitations of different roads;

- Do not drive faster than 30 mph;
- To avoid the tyre damage and excessive wear of the tyre/snow chains, the tyre/snow chains must be removed while driving on the road without snow.

Size and Specifications of Wheels and Tyres Supporting Tyre/Snow Chains for This Vehicle	
Wheel Rim Size	7.0J×17
Tyre Size	215/50 R17

Note: *If you often drive on the snowy and icy roads, it is recommended to use winter tyres. Consult an MG Authorised Repairer for details.*

SERVICE AND MAINTENANCE

Cleaning and Vehicle Care



Observe all safety precautions on cleaning products; Do Not drink fluids and keep them away from the eyes.

Exterior

Washing Your Car



Do not clean the front compartment with high pressure water since it may damage the electrical system of the vehicle.



Some high pressure cleaning systems will penetrate door, window and sunroof seals, and damage lock mechanisms. DO NOT aim water jets directly at components that might be easily damaged. Ensure the vehicle power system is OFF when washing your car.

In order to preserve the paint finish on your car, please observe the following care points:

- DO NOT use hot water to wash the car.
- DO NOT use detergents or washing up liquid.

- In hot weather, DO NOT wash the car in direct sunlight.
- When using a hose, DO NOT aim the water directly at window, door or sunroof seals, or through wheel apertures onto the brake components.

If the car is particularly dirty, use a hose to flush grime and grit from the bodywork, prior to washing. Then, wash the car using cold or lukewarm water containing a good quality wash and wax shampoo. Always use plenty of water to ensure that grit is flushed from the surface and not ground into the paintwork. After washing, rinse the bodywork with clean water and dry off with a chamois leather.

Cleaning the underside

Note: DO NOT use a high pressure hose to clean the front compartment – damage to the car's electronic systems may occur.

IMPORTANT

- Always read the manufacturers operating instructions.
- DO NOT direct the pressure washer nozzle directly toward the high voltage charging point or high voltage battery connections on the underside of the vehicle.

Polishing the Paintwork

Occasionally treat the paint surface with an approved polish containing the following properties:

- Very mild abrasives to remove surface contamination without removing or damaging the paint.
- Filling compounds that will fill scratches and reduce their visibility.
- Wax to provide a protective coating between the paint and the elements.

Note: *If possible, avoid applying polish or wax products to window glass and rubber seals.*

Paint Damage

Any paint damage or stonechips should be treated with suitable paint/lacquer materials immediately to avoid invalidating the Anti Corrosion Warranty.

Wiper Blades

Wash in warm soapy water. DO NOT use spirit or solvent based cleaners.

Windows and Mirrors

Regularly clean all windows, inside and out, using an approved glass cleaner.

Windscreen: In particular, clean the outside of the screen with glass cleaner after washing the car with wash and wax products, and before fitting new wiper blades.

Rear screen: Clean the inside with a soft cloth, using a side to side motion to avoid damaging the heating elements.

Mirrors: Wash with soapy water. Use a plastic scraper to remove ice. DO NOT use abrasive cleaning compounds or metal scraper.

SERVICE AND MAINTENANCE

Plastic Components

Any plastic components should be cleaned using conventional cleaning methods and not be treated with abrasive materials.

Removing tar spots

Use white spirit to remove tar spots and stubborn grease stains from the paintwork. Then wash the area immediately with soapy water to remove all traces of the spirit.

Wheels



When cleaning the wheels any materials or water that contact the brake.

In order to ensure the wheels are kept in optimum condition they should be cleaned regularly.

Only use a recommended non-acidic proprietary wheel cleaner. Always read the instructions on the product.

Cleaning the underside



DO NOT use a high pressure hose to clean the front compartment – damage to the car's electronics systems may occur.

From time to time, but particularly during winter months when salt has been used on the roads, use a hose to wash the underside of the car. Flush away accumulations of mud and thoroughly clean those areas where debris can easily collect (wheel arches and panel seams, for example).

Cleaning the Interior

Plastic materials

Clean plastic-faced materials with diluted upholstery cleaner, then wipe with a damp cloth.

Note: *DO NOT polish dashboard components – these should remain non-reflective.*

Carpet and fabrics

Clean with diluted upholstery cleaner - test a concealed area first.

Leather

Clean leather trim with warm water and a non-detergent soap. Dry and polish the leather with a dry, clean, lint-free cloth.

Note: *DO NOT use petrol, detergents, furniture creams or polishes as cleaning agents.*

Instrument Pack, Infotainment Display

Clean with a dry cloth only. DO NOT use cleaning fluids or sprays.

Airbag Module Covers



DO NOT allow these areas to be flooded with liquid and DO NOT use petrol, detergent, furniture cream or polishes.

To protect damage to the airbag SRS, the following areas should be cleaned sparingly with a damp cloth and upholstery cleaner ONLY:

- Steering wheel centre pad.
- Area of dashboard containing the passenger airbag.
- Area of roof lining and front pillar finishers which enclose the side head impact protection modules.

Seat Belts



DO NOT use bleaches, dyes or cleaning solvents on seat belts.

Extend the belts, then use warm water and a non-detergent soap to clean. Allow the belts to dry naturally; DO NOT retract them or use the car until they are completely dry.

Technical Data

316 Technical Data Dimensions

318 Weights

320 Electric Drive Transmission

*321 Recommended Fluids and
Capacities*

*322 Four-Wheel Alignment Parameter
Table (Unladen)*

323 Wheels and Tyres

324 Tyre Pressure (Cold)

TECHNICAL DATA

Technical Data Dimensions

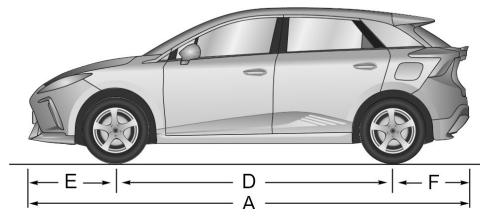
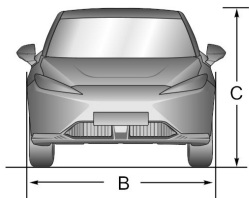

Item, Units	Parameter
Overall length A , mm	4287
Overall width B , mm	1836
Overall height C unladen, mm	1504
Wheelbase D , mm	2705
Front overhang E , mm	841

TECHNICAL DATA

Item, Units	Parameter
Rear overhang F , mm	741
Front wheel track, mm	1550
Rear wheel track, mm	1551
Minimum ground clearance, mm	117

Note: *Vehicle length not including the license plate.*

Note: *Rearview mirrors and the deformed portion of tyre wall directly above the touchdown point are not included in the total width*

TECHNICAL DATA

Weights

Item, Units	Parameters				
	STD	COM-11KW	COM-6.6KW	LUK-11KW	COM-6.6KW
Person in cab, person	5				
Unladen vehicle weight (kerb), kg	1635	1651	1648	1665	1662
Gross vehicle weight, kg	2083	2113	2113	2113	2113
Unladen front axle weight, kg	798	806	804	813	811
Unladen rear axle weight, kg	837	845	844	852	851
Gross front axle weight, kg	920	935	935	935	935
Gross rear axle weight, kg	1163	1178	1178	1178	1178

Towing Weights

Item, Units	Parameters
Towing limit unbraked, kg	500
Towing limit braked, kg	500
Towing hitch load, kg	50

Note: When towing a trailer, the vehicle speed **MUST** not exceed 60 mph.

Note: Prior to towing a trailer, please check the rear tyre pressures, inflate to at least 20 kPa (0.2 bar, 3 psi) above the recommended pressure - **DO NOT** allow the tyre pressure to exceed 300 kPa (3.0 bar, 44 psi), this can be dangerous.

TECHNICAL DATA

Electric Drive Transmission

Item, Units	Type 1	Type 2
Traction motor type	Three-phase permanent magnet synchronous motor	Three-phase permanent magnet synchronous motor
Continuous Power/Maximum NetPower, kW	68/150	54/125
Peak Torque, Nm	250	250
Rated Speed/Maximum Speed, rpm	8000/17000	8000/17000
Waterproof Grade	IP67	IP67

Recommended Fluids and Capacities

Name	Grade	Capacity
High voltage battery pack coolant, L	Glycol (OAT)	4.0
Electric drive transmission coolant, L		5.6
Electric drive transmission fluid, L	Shell E-Fluids E6 iX (SL2808)	0.9
Brake fluid, L	DOT 4	0.8
Washer fluid, L	ZY-VIII	2.5
Air conditioning refrigerant, g	R-1234yf	580 ± 20

TECHNICAL DATA

Four-Wheel Alignment Parameter Table (Unladen)

Items		Parameters
Front Wheel	Camber	$-12 \pm 45 \phi$
	King Pin Caster Angle	$6^{\circ}50 \pm 45 \phi$
	Toe in (Total)	$6 \pm 12 \phi$
	King Pin Inclination	$12^{\circ}45 \pm 45 \phi$
Rear Wheel	Camber	$-1^{\circ} \pm 45 \phi$
	Toe in (Total)	$12 \pm 12 \phi$

Wheels and Tyres

Wheel Rim Size	7.0JX17
Tyre Size	215/50 R17 95V

TECHNICAL DATA

Tyre Pressure (Cold)

Wheels	Half-load	Laden
Front Wheels	250kPa/2.5bar/37psi	250kPa/2.5bar/37psi
Rear Wheels	250kPa/2.5bar/37psi	280kPa/2.8bar/41psi